

MAXXUS[®]

RunMaxx 7.4
Treadmill



ENG

Index

Index	2
Safety Instructions	3
Overall View of the Device	4
Scope of Delivery	4
Assembly	5 – 8
Folding Mechanism	9-10
Transport	10
Mains Connection	11
Safety Distance	11
Disabling Function	11
Safety Key	12
What to do in an Emergency	12
Maintenance & Care	13 – 15
Cockpit	16 – 30
Pulse & Heart Rate	31 – 32
Training Recommendations	33 – 34
Technical Details	35
Disposal	35
Recommended Accessories	35
Exploded Drawing	36 – 37
Spare Parts List	38 – 39
Warranty	42
Service Contract	43

© 2019 MAXXUS Group GmbH & Co. KG
All rights reserved / All rights reserved

This publication may not be reproduced, stored in a retrieval system, or transmitted in whole or in part, in any form or by any means, electronic, mechanical, photocopying, recording, or otherwise without the prior written permission of Maxxus Group GmbH & Co. KG.

Errors, colour and technical modification subject to change, reproduction as well as electronic duplication only with written permission of MAXX-US Group GmbH & Co. KG.

Before you start exercising, be sure to read the entire operating manual, especially the Safety Information, the Maintenance and Cleaning Information and the Training Information. Also make sure that anyone else who uses this training device is familiar with this information and observes it.

Always follow the maintenance and safety instructions in this manual very carefully.

This training device may only be used for its specific intended use. Any misuse can cause risk of possible accident, damage to health or damage to the device for which the Distributor will not assume any liability.

Electrical Connection

- A mains voltage of 220-230V is required to operate this training device.
- The training device is only to be connected to the mains with the mains cable supplied using a 16A individually fused and earthed socket installed by a qualified electrician.
- The training device is only to be switched on and off using the ON/OFF switch.
- Always remove the electric plug from the socket before moving the training device.
- Remove the electric plug from the socket before commencing any cleaning, maintenance or other works.
- Do not connect the mains plug to a socket on a socket strip or on a cable drum.
- If using a cable extension please ensure that this complies with DIN standards, VDE regulations and guidelines, technical rules issued by other European Union states.
- Always place the mains cable so it cannot be damaged or cause a tripping hazard.
- In operating or standby mode, electrical devices such as mobile phones, PCs, Televisions (LCD, plasma, tube, etc.), game consoles etc. will emit electro-magnetic radiation. For this reason, all these types of devices should be kept away from your training device as they could lead to malfunction, disturbances or false outputs being shown in heart rate measurements.
- For safety reasons, always remove the electrical plug from the socket when the device is not in use.

Training Environment

- Select a suitable space for your training device to provide an optimum amount of free space and highest level of safety. You should leave a free space measuring a minimum of 200 cm long and at least the width of the treadmill behind the device. A free space measuring a minimum of 50cm long and at least the width of the treadmill should be left in front of the device.
- Make sure that the area is well ventilated and that an optimum amount of oxygen is available during training. Avoid draughts.
- Your training device is not suitable for outside use and so storage and training can only take place in a temperate, clean dry room.
- The temperature range to operate or store this device is between a minimum of 10° and maximum of 30°
- Do not operate or store your training device in wet areas such as in swimming pools, saunas etc.
- Make sure that your training device is kept on flat, hard, clean ground both in operation and at rest. Any uneven surfaces must be removed or made good.
- It is recommended that a floor covering (carpet, mat, etc.) should be placed under the device to protect damageable floors such as wood, laminates, floor tiles etc. Please ensure that this underlay cannot slip or slide.
- Do not put this training device on pale or white coloured carpets or rugs as the feet of the device may leave marks.
- Make sure that your training device and mains cable are kept out of contact with hot surfaces and are kept at a safe distance from any sources of heat e.g. central heating, hot stoves, furnaces, ovens or open fires.

ENG

Personal Safety Instructions for Training

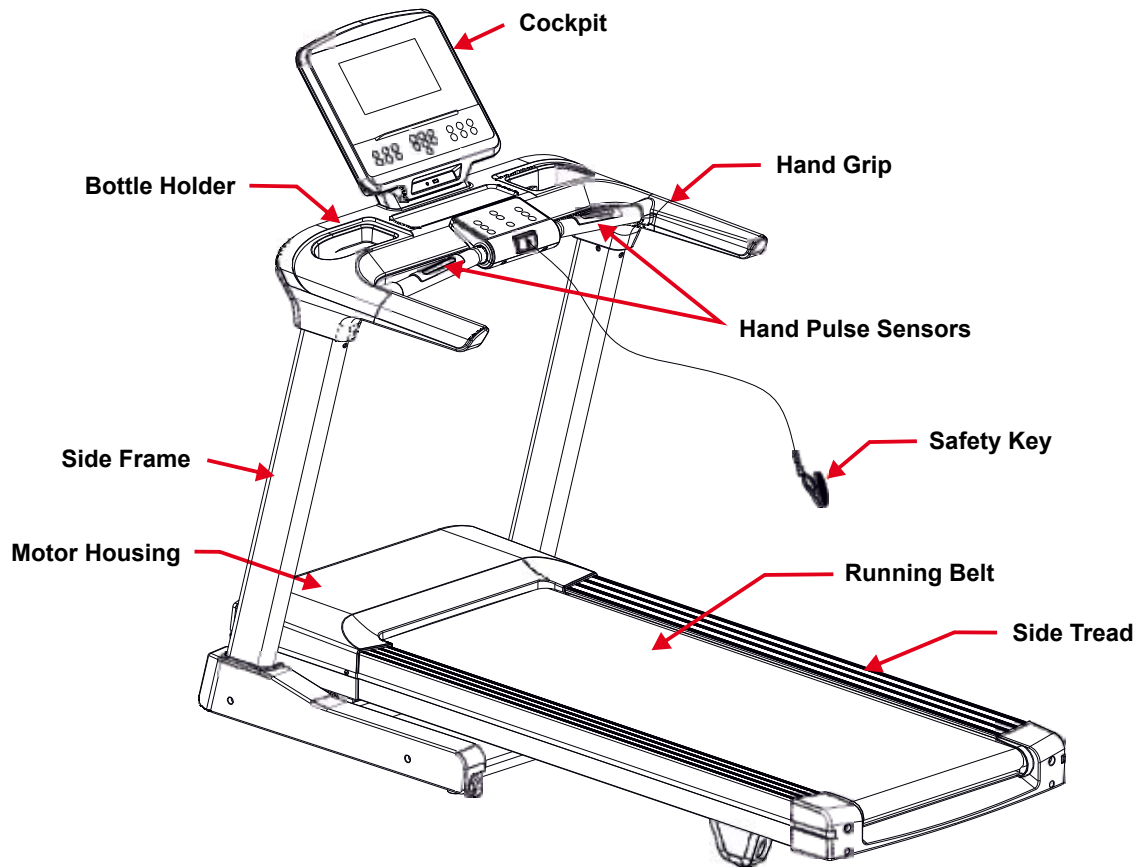
- The safety key must be inserted correctly before each training session can begin.
- Remove the safety key and mains cable from the training device when not in use to avoid inappropriate or uncontrolled use by any other third party, e.g. children.
- You should have a health check carried out by your doctor before you start any training
- Stop training immediately if you feel physically unwell or are experiencing any breathing difficulties.
- Always start your training session at a low workload increasing it slowly but steadily throughout. Reduce the workload again towards the end of your training session.
- Suitable sports shoes and clothes should always be worn during training sessions. Make sure that loose clothes do not get caught up in the treadmill belt or rollers.
- Your training device is only to be used by one person at a time.
- Check each time before a training session to see if your device is in perfect condition. Never use your training device if it is faulty or defective.
- You are only permitted to carry out repairs to the device yourself after having contacted our Service Department and on receipt of explicit permission to do so. Only original spare parts may be used at any time.
- Your training device must be cleaned after each use. Remove all dirt including body sweat or any other liquids.
- Always make sure that liquids (drinks, body sweat, etc.) do not get onto the vibrating plate or into the cockpit as this can cause damage to the mechanical and electronic components.
- Your training device is not suitable for use by children.
- Third parties, especially children and animals, must be kept at an appropriate safety distance during training.
- Check if there are any items underneath the training device before each training session and remove them without fail. Never use the training device when items are underneath it.
- Do not allow children to use your training device as a toy or climbing frame at any time.
- Ensure that no body parts of your own or of third parties ever come in contact with any of the moving mechanisms.

Warning for pulse and heart rate measurement

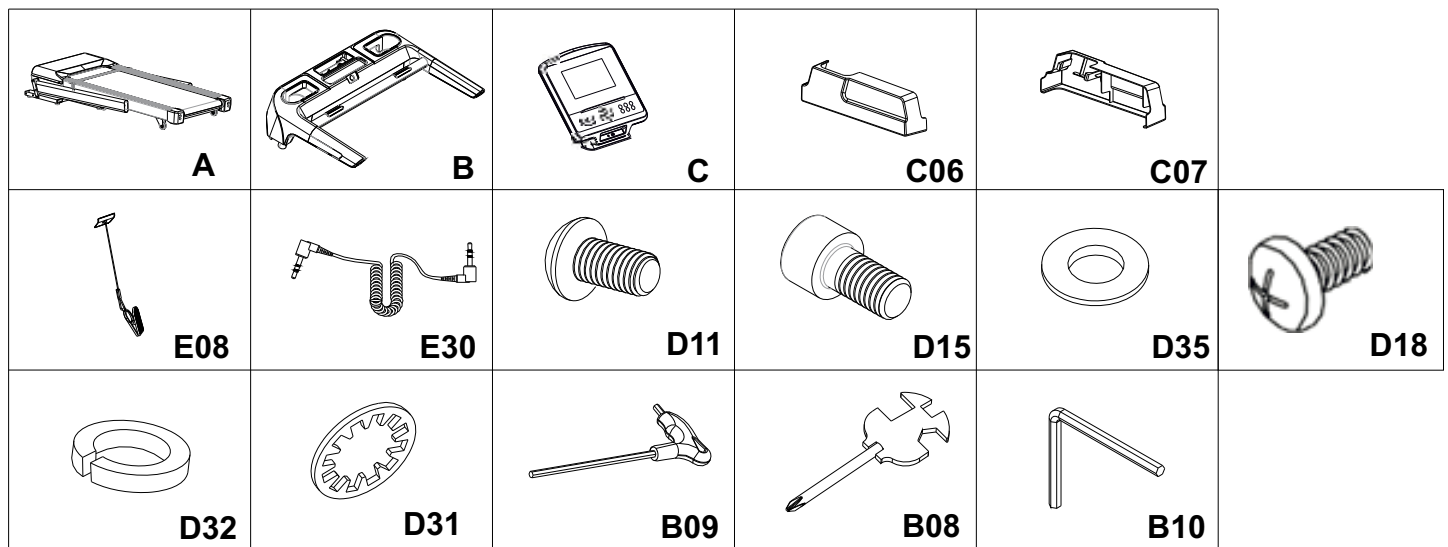
Pulse and heart rate monitoring systems may be inaccurate. Excessive training can lead to serious injury or lead to death. If you feel unwell and / or faint, you must stop training immediately. Make sure that all persons using this exercise device are familiar with and understand this information and abide by it without fail.

The construction of this training device is based on state-of-the-art technology and highest modern technical safety standards. This training device is to be used by adults only! Extreme misuse and/or unplanned training can cause damage to your health!

Overall View of the Device



Scope of Delivery



Part	Description	Qty
A	Main Frame	1
B	Cockpit Frame	1
C	Cockpit	1
C06	Cover, left	1
C07	Cover, right	1
E08	Safety Key	1
E30	RCA audio cable	1
D11	Hexagon socket screw M8x15	10

Part	Description	Qty
D15	Hexagon socket screw, M8x15	4
D18	Pan head screw M5x16	4
D35	Washer M8	4
D32	Spring washer, M8	4
D31	Locking washer, M8	10
B09	Allen key, 6mm	1
B08	Wrench / Phillips screwdriver	1
B10	Allen key, 5mm	1

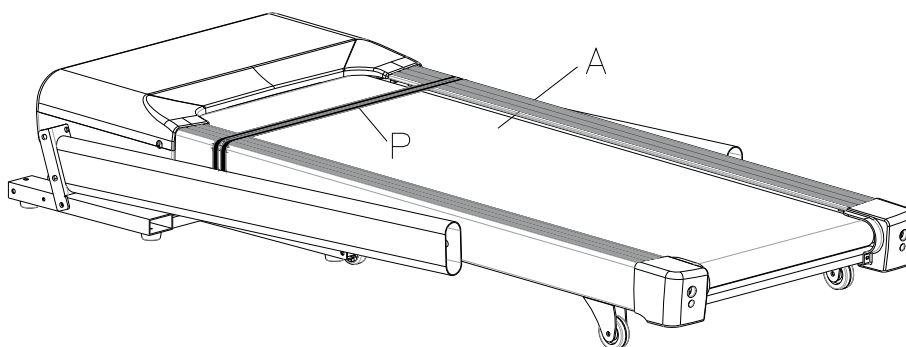
Carefully unpack all of the delivered items. Two people are required as some parts of your exercise equipment are bulky and heavy. Check that all of the fastening material (screws, nuts, etc.) and components are there before starting assembly.

Carefully carry out the installation as damage that has arisen due to assembly errors are not covered by the warranty or guarantee. Read the instructions carefully before starting, follow the sequence of installation steps exactly and follow the instructions for each individual step. Installation of the device must be carried out by competent adults. Perform the assembly in a location that is level, clean and free from obstructions. Carry out the assembly with two people. Only start training after fully completing the installation.

Preparing for Assembly

Unpack the main frame (A) and place it in the designated assembly area which should be level and clean.

ATTENTION: Do not remove the transport safety strap (P) until you are instructed to do so, premature removal of the safety strap (P) can cause the tread to fold up suddenly.



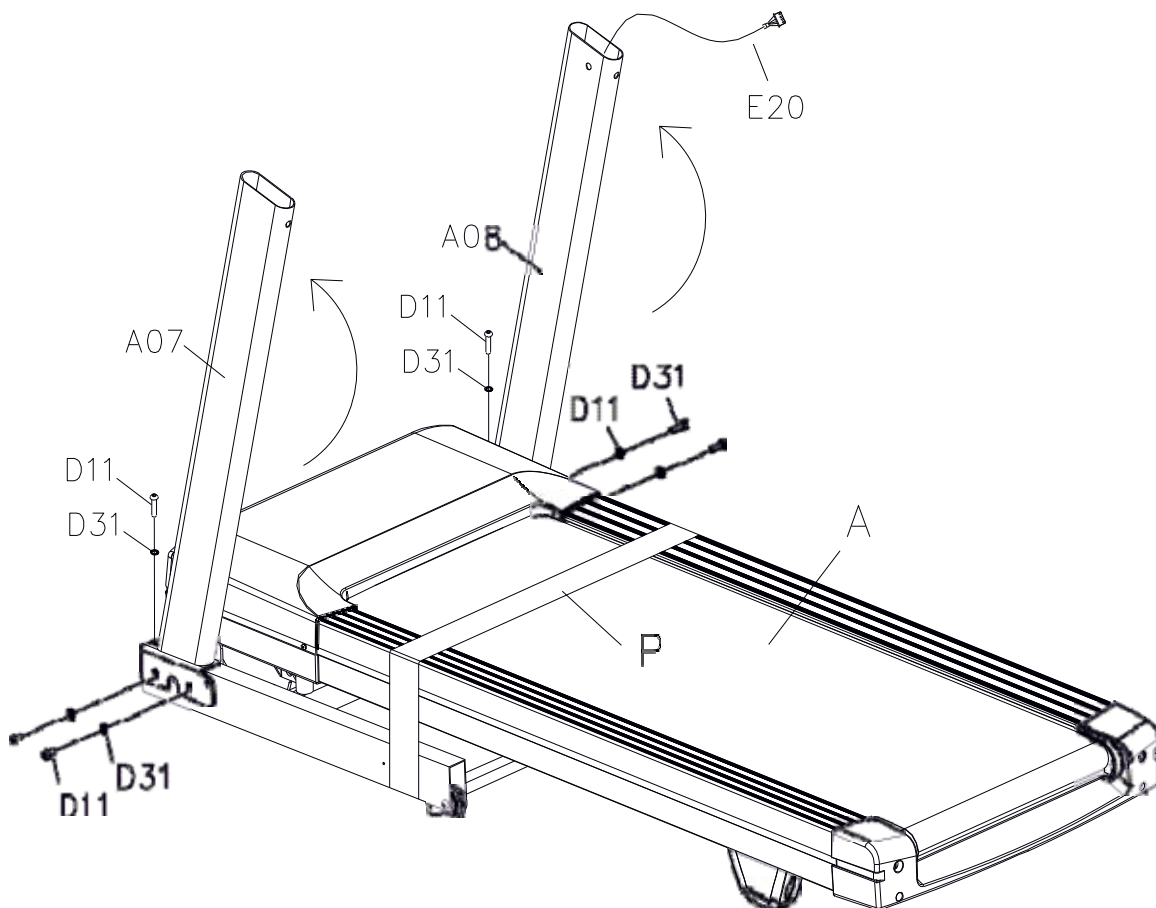
Step 1 - Assembly of the Side Frames:

Fold up the left side frame (A07).

Attach the left side frame (A07) to the main frame from the side with two Allen bolts M8x15 (D11) and two M8 locking washers (D31) and from above with an M8x15 Allen bolt (D11) and an M8 washer (D31).

ENG

Then do the same with the right side frame (A08).



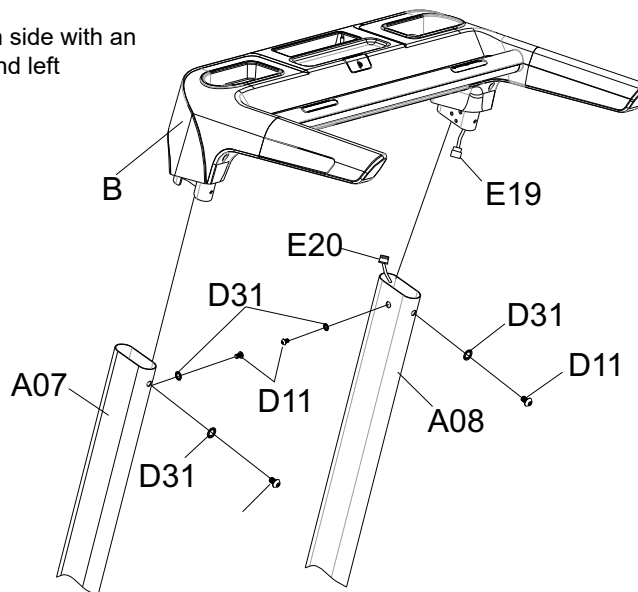
Step 2 - Assembly of the Cockpit Frame:

Connect the cable (E20) that protrudes from the top of the right-hand side frame with the cable (E19) that protrudes from the right-hand side of the cockpit frame (B).

Then insert the cockpit frame (B) from above into the side frames (A07 / A08).

ATTENTION: Make sure that you do not squeeze or damage the cables.

Secure the cockpit frame (B) from the front and the inside each side with an Allen bolt M8x15 (D11) and an M8 washer (D31) on the right and left side frames (A08/ A07).



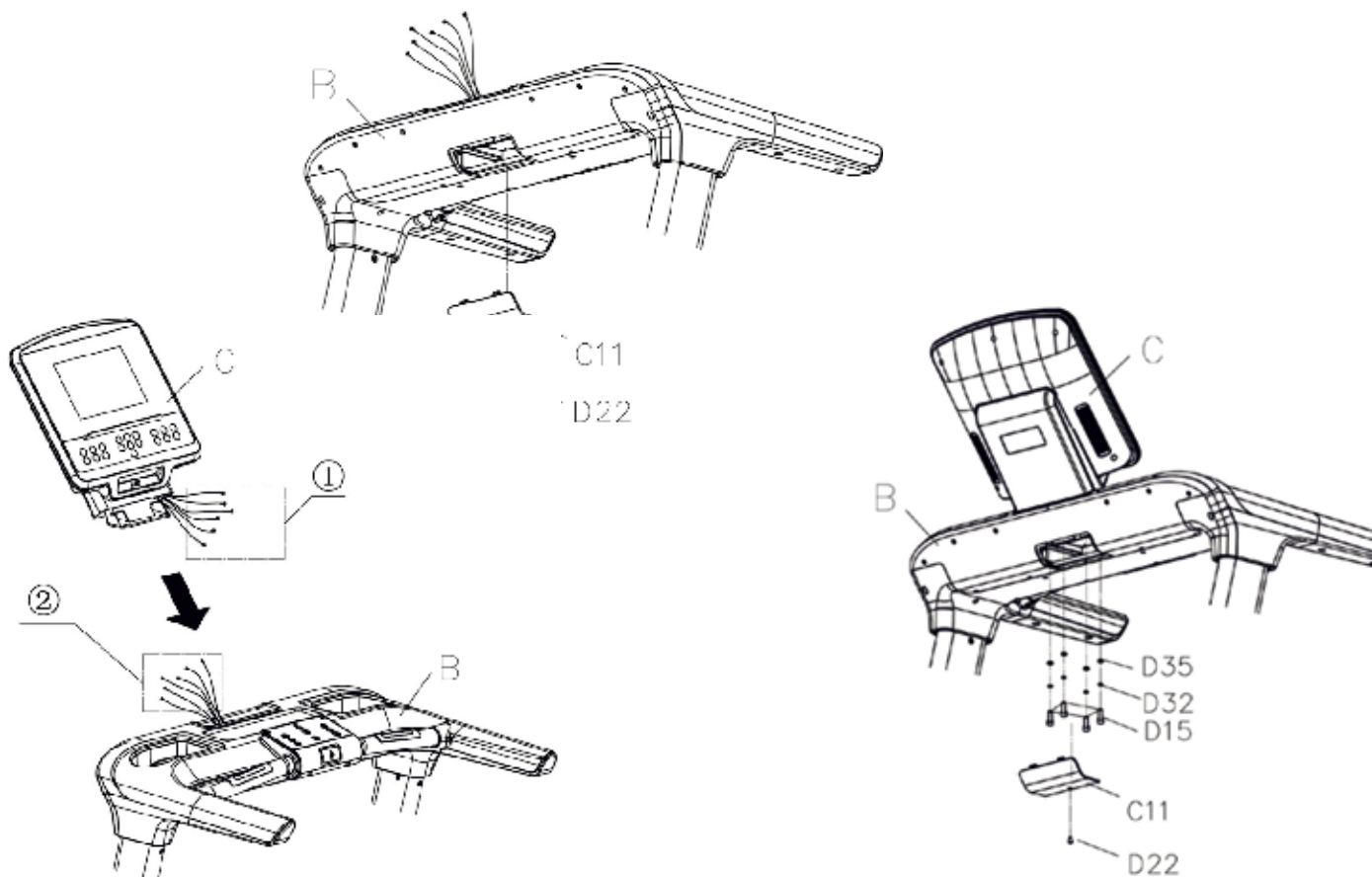
Step 3: Assembly of the Cockpit

Remove the cover (C11) from the underside of the cockpit frame (B) by loosening and removing the screw (D22).

Connect the cables from the cockpit (C) with the cables that protrude from the cockpit frame (B). Insert the cockpit (C) in the cockpit frame (B).

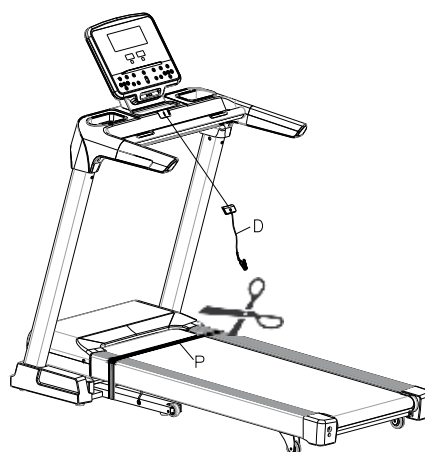
ATTENTION: Make sure that you do not crush or damage the cables.

Attach the cockpit (C) to the cockpit frame (B) with four Allen bolts M8x15 (D15), four spring washers M8 (D32) and four washers M8 (D35).



Step 4 - Insert the Safety Key

Insert the safety key (D) in the cockpit. Cut and remove the transport belt (P).

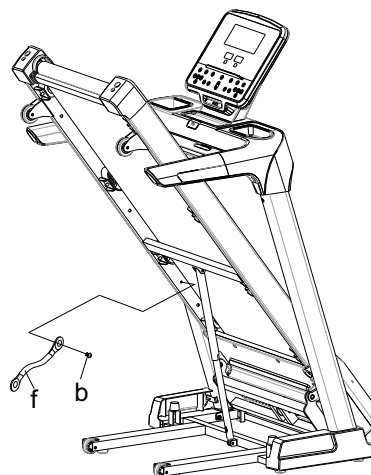
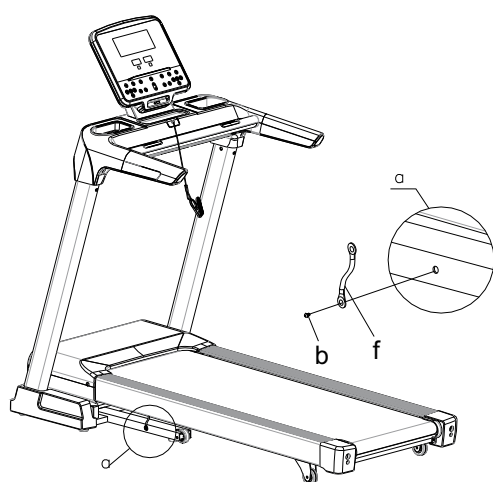


Step 5 - Remove the Transport Lock

Loosen and remove the Allen bolt M8x15 (b) which fastens the steel cable (f) to the main frame (position a).

Lift up the treadmill deck.

Note: Keep the steel cable (f) and the two screws (b) to use if you need to transport the treadmill in future.

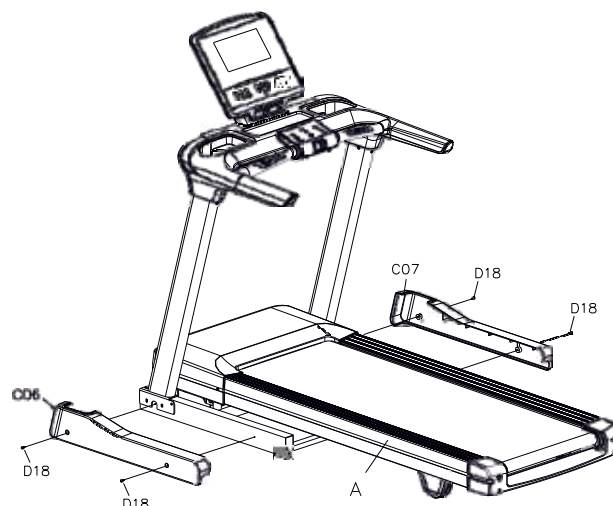


ENG

Step 6 - Assembly of the Side Covers

Insert the left side cover (C06) into the main frame (A) and secure with two M5x16 pan head screws (D18).

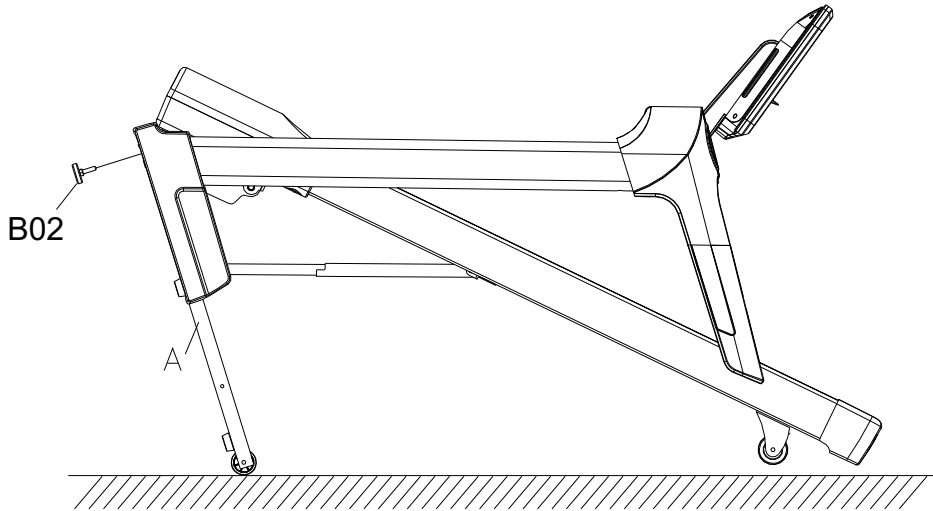
Repeat with the right side cover (C07).



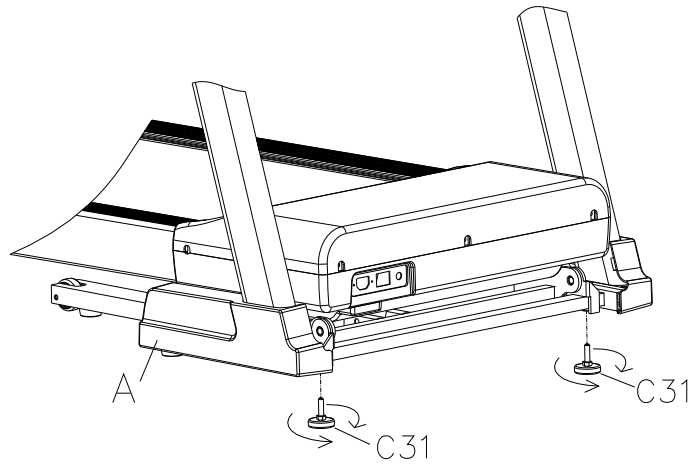
Step 7 - Adjusting the Feet

To compensate for slight bumps in the location where you want to set up and use the treadmill, the front feet (B02) of the treadmill are equipped with adjustment screws.

Fold up the deck of the treadmill and carefully lay the treadmill on the floor as shown in picture A.



Adjust the two feet (B02) so that the treadmill is level. Use a suitable wrench (B08 included in delivery) to fix the feet (B02).



Step 8 - Checking the Lubrication of the Treadmill Belt

The treadmill belt has been lubricated at the factory but there is a possibility that the lubrication may have dried out slightly due to delivery time, storage time and warm weather.

For this reason, check if the running belt is sufficiently lubricated and lubricate if necessary. Please read the chapter "Lubricating the Treadmill Belt" in this manual.

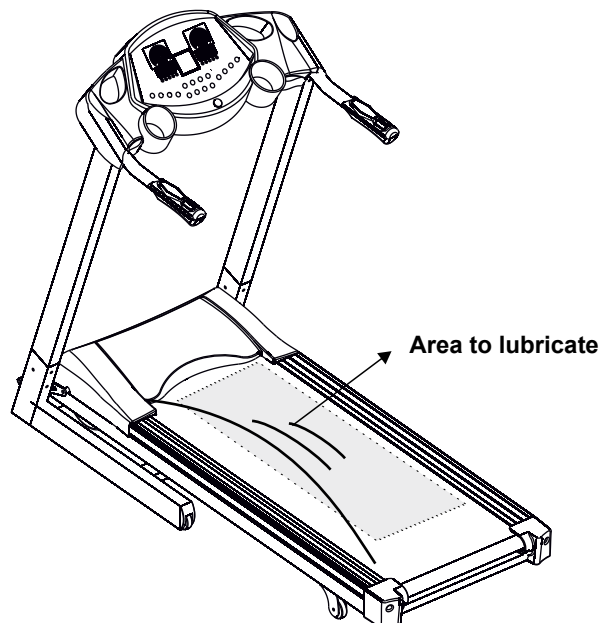


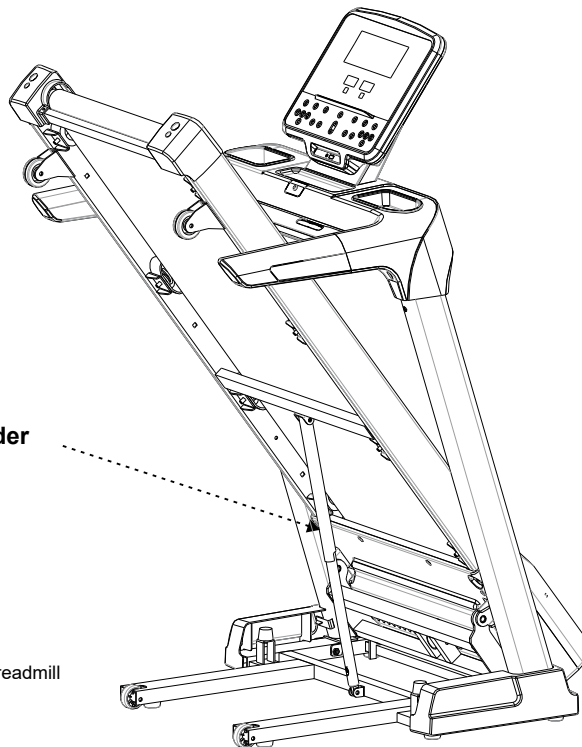
Figure shows similar treadmill

Hydraulic Cylinder

The folding mechanism relies on a hydraulic cylinder. This is filled with oil and is under high pressure. If the cylinder is damaged, the safe folding of the treadmill deck is no longer guaranteed. It must therefore be replaced without fail before the treadmill deck is raised again.

Hydraulic Cylinder

Figure similar to the treadmill



This treadmill is equipped with a folding mechanism. To save space, fold the treadmill deck up and down as follows:

Folding up the Treadmill Deck

Step 1:

Make sure that the deck incline level is at "0", switch the treadmill off at the main switch and remove the mains plug from the socket.

CAUTION:

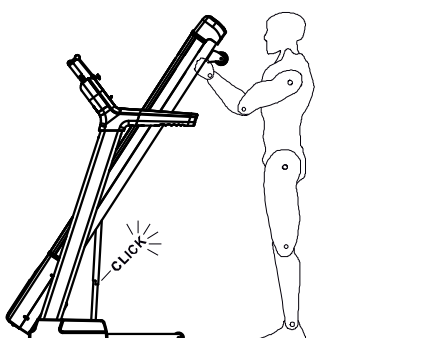
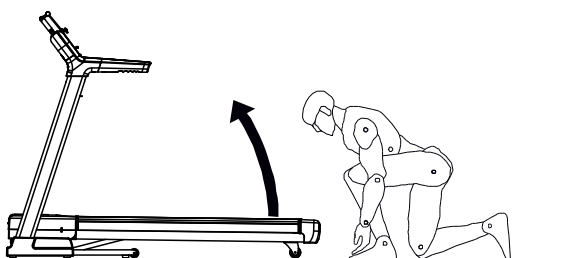
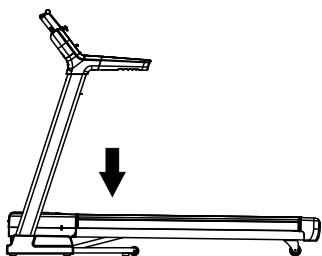
Never fold up the treadmill deck without the incline in "0" position or without switching it off.

Step 2:

Hold onto the rear end of the treadmill deck and lift it upwards. Make sure that you are standing with your feet firmly on the ground.

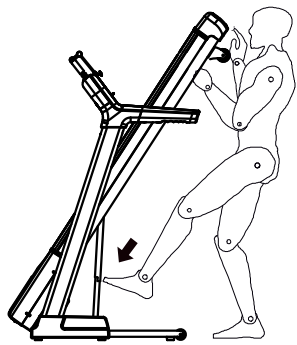
Step 3:

Push up the deck until you hear it click into the catch. Check that it is locked safely in the upright position by gently shaking the deck.



ENG

Folding Mechanism



Folding Down the Treadmill Deck

Step 1:

Take hold of the rear end of the deck with both hands. Press down the safety lever on the catch with your foot to release the lock. Pull the treadmill deck down gently to the floor.

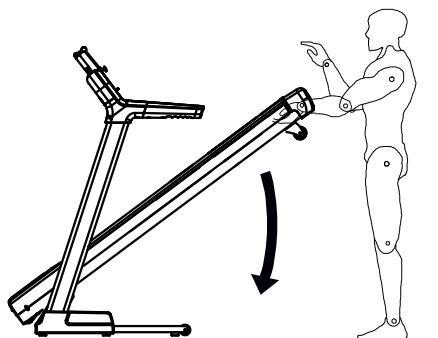
Step 2:

The treadmill deck is equipped with a Soft-Fold-System.

This allows the deck to move slowly down until it reaches contact with the floor. You should never leave the deck to fold down unsupervised.

CAUTION:

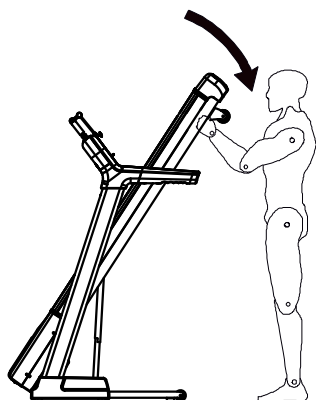
Children are never to fold-up or fold-down the treadmill running deck. Always make sure that there are no items, creatures, pets or children under the treadmill deck whilst it is being raised or lowered. The treadmill must never be operated whilst in this folded state.



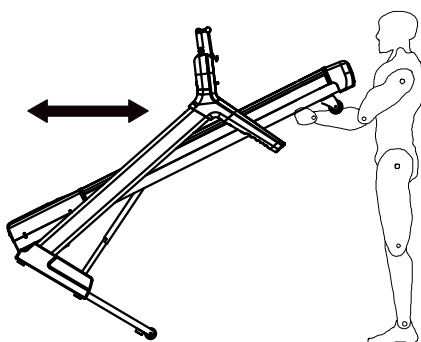
Transport

When folded, the treadmill can be moved around easily and without much effort.

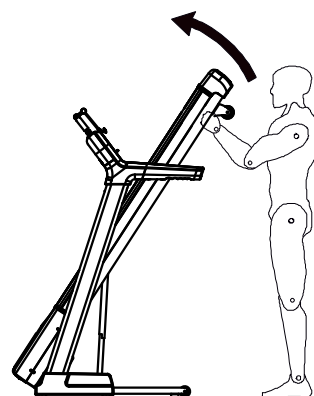
Move the treadmill as follows:



Step 1



Step 2



Step 3

Figure similar to the treadmill!

Step 1:

Remove the mains cable from the electrical socket. Fold up the treadmill as instructed above in the Folding Mechanism section. Take hold of the top ends of the deck on both sides with your left and right hands and pull the deck towards you until the weight of the deck is resting on the transport rollers. Make sure that you are standing with your feet firmly on the ground.

Step 2:

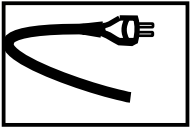
The treadmill can now be moved easily and without much effort. Make sure that there are no items, pets or children in the way when you are moving the treadmill. Make sure that your feet are steadily on the ground when moving the treadmill.

Step 3:

To set the treadmill safely down again, lift the deck right up until the front frame base is completely on the ground.

CAUTION:

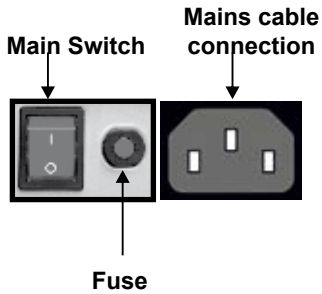
The treadmill should only be moved by an adult.



Mains Cable

Connect the power cable to an electrical socket.

The device may only be plugged-in to grounded socket which has been installed by a professional electrician. Do not use multiple sockets to connect the treadmill. If you need to use an extension cable, it must comply with the VDE or equivalent guidelines.



May vary depending on the model

Main Switch

The main switch is located next to the power connection on the front of the treadmill. This switch is used to turn the treadmill on or off.

Switch position "I" = treadmill switched on

Switch position "0" = treadmill switched off

Fault-Current Switch (depending on the model)

There is a fault-current button-switch next to the main switch on the front of the motor cover to prevent the treadmill from being damaged by electrical surges in the network. This button-switch is triggered off by if a surge in the electrical supply occurs and acts as a circuit breaker. In this case the treadmill will be completely switched off. If this occurs, switch off the treadmill at the main switch, and pull the mains cable out of the socket with the plug. Press the button on the fault-current switch back in. Re-connect the mains cable with the plug and switch the treadmill back on at the main switch.

Fuse (depending on model)

To protect the treadmill from damage caused by overvoltage of the mains there is a fuse next to the main switch on the front of the engine cover. This breaks the circuit in the event of an overvoltage, the treadmill is completely switched off. If this happens, turn off the treadmill with the main power switch and unplug the power cable from the wall socket. Check the fuse and replace if necessary. Then re-connect the power cable to the socket and switch the treadmill back on using the main switch.

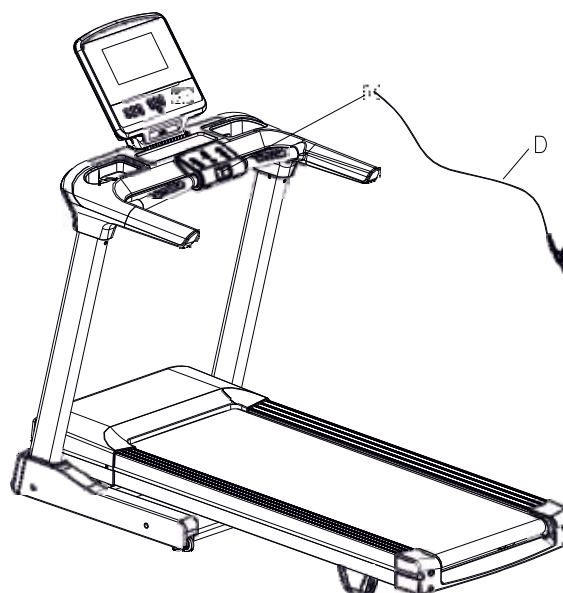
Safety Distance

Select a suitable place for your training device which when in operation leaves a free safety area behind the device measuring a minimum of 200 cm long and which is at least the width of the treadmill.

Furthermore, whilst training on the treadmill you will require a minimum safety area of 100cm down each side of the treadmill and a safety area stretching at least the width of the treadmill for a minimum of 50cm in front of the treadmill.

Disabling Function

To protect the treadmill from being used by unauthorised third parties, always remove the mains cable and the safety key when not in use and keep them stored away in a separate place and out of the reach of unauthorised persons, such as children.



Safety Key

Safety Key

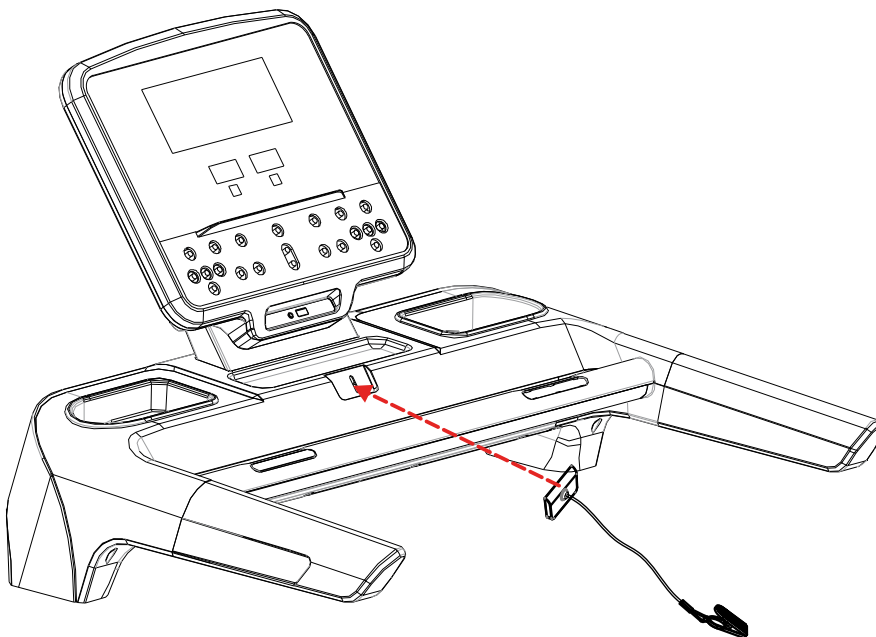
The treadmill will only operate if the safety key is correctly in contact with contact point in the cockpit. The treadmill will stop automatically if the safety key is no longer in contact.

Before each training session make sure to attach the safety key to your clothing with the clip.

If you either want to stop the treadmill quickly, cannot keep up with the speed, or any other emergency arises, pull the string to remove the safety key out of the cockpit. If the safety key is connected to your clothing it will automatically be pulled out of the cockpit if you fall. It is therefore vital to make sure that the clip is securely fastened to your clothing and cannot somehow be pulled off. Adjust the length of the string to hang down loosely during training.

It is not possible to operate the treadmill without the safety key being correctly inserted.

If the safety key is pulled from the contact point during training the treadmill stops automatically.



Functional Test of the Safety Key

Check the proper function of the safety key each time before using the treadmill. To do this, start the treadmill without getting on it. Pull the safety key out of its contact position. The treadmill should stop immediately.

CAUTION:

Never use the treadmill if the safety key is not working properly

What to do in an Emergency

Stop training immediately if you realise that you cannot keep up with the pace, if you start feeling sick or if any other emergency arises, pull the safety key out with the string to make an emergency stop.

Hold on firmly with both hands onto the handrails and place your feet on the foot rails on each side of the tread belt.

If you trip during training, hold onto the handrails immediately with both hands, support yourself with your hands and arms on the handrails and put your feet on the foot rails on either side of the tread belt.

You should practice this several times so that you will know what to do if an emergency arises.

Wear the safety key every time you use the treadmill. Make sure that all third parties are familiar with the safety instructions and that they always use the safety key correctly whilst training!

⚠ CAUTION:

Before you perform any care, cleaning, maintenance, repair or similar work on your training device, switch off the power and remove the power cable from the electrical socket. Check before starting the planned work that your exerciser is completely disconnected and switched off. Only when all work is fully completed, and the device is completely re-assembled, may the training device be reconnected to the mains and switched on.

Before first use or after a long break from training

Check that the treadmill is safe. There must be no objects on or under the device. Make sure that there is a continuous film of lubricant (silicone) on the running deck. If this is not the case, then use the supplied silicone to apply a lubricant film.

Maintenance & Cleaning Intervals:

After each workout, clean the treadmill with a damp cloth to remove possible perspiration and / or other liquid residues. Under no circumstances use solvents for this purpose. Dry the cleaned areas thoroughly.

Check the lubrication of the running belt: once a week

If your regular checks show that there is no longer enough lubrication, lubricate the belt immediately and shorten the checking interval accordingly as necessary. If the treadmill has a folding mechanism and has been standing upright for a long time, check whether there is still enough lubricant present.

Check the alignment of the belt: once a week

The alignment of the running belt must be checked regularly. Should you notice that the belt is running to one side, this must be corrected immediately. Please read the corresponding section in the manual.

Clean the motor compartment: once a month

To clean the motor compartment, remove the motor cover bolts and cover.

CAUTION: This work may only be performed when the training device is switched off and the power plug is removed. Vacuum the visible dust with the small nozzle of a vacuum cleaner. Never use detergent or compressed air under any circumstances.

Check the mounting materials: once a month

Check the bolts and nuts at least once a month. Tighten, if necessary.

ENG

Why is maintenance of my treadmill so important?

For you to enjoy your treadmill for a long time, it is important to do some basic maintenance regularly and conscientiously. The intervals of this work depend very much on the degree of utilisation of the device and therefore, the intervals may need to be shorter than specified.

What can happen if there is a lack of maintenance?

There is friction between the running belt and the running deck when in use. Any kind of friction means wear and thus reduces the life of your training device. By lubricating between the belt and the deck with silicone this friction is reduced, thus increasing the life of both parts. If the treadmill runs dry the running deck will get hot, the surface of the running deck and the running belt may be destroyed. Friction can also lead to a static charge which can discharge on body contact with the frame. This is not only unpleasant but can also destroy the electronics of the treadmill.

Why do I have to clean the motor compartment?

Due to movement of the running belt and ventilation of the motor, the treadmill attracts dust from the environment. This dust will be deposited both under and in the device. Without cleaning, the interior of the device would at some point get so dusty that a short would be caused in the electronic components. To avoid this, regular cleaning is necessary.

Damage caused by neglect or lack of maintenance and care are excluded from the Warranty and Guarantee.

Costs for the repair of a non-maintained training device can therefore quickly amount to several hundred euros. A high price that can be avoided by regular care and maintenance

Lubricating the Treadmill Belt

The most important maintenance work to do to a treadmill is regular and timely lubrication and care and maintenance of the belt. Damages or defects caused by failure or lack of maintenance and care are in no way covered by the warranty or guarantee.

The treadmill belt must always be lubricated if a significant increase of friction is detected. This will become apparent if the belt makes jerking movements during training or if fault message E1 appears in the display on the cockpit. Insufficient lubrication or care and the resulting increase in friction will inevitably lead to an increase in wear and cause damage to the treadmill belt, deck, motor and circuit board.

How often you use the treadmill will generally determine how often you must carry out the maintenance measures. As this varies from person to person, we would recommend that you keep a maintenance book. You should set a specific day every week in the first 6 months of use to check the treadmill belt lubrication.

Lift up the front third part of the belt and feel with your hand if there is still lubrication in the middle of the belt. If lubrication is present, then write "ok" next to the date in your maintenance book. If there is little or no lubrication present, then lubricate the belt and write this down in your maintenance book accordingly. In time it will be possible to see at what time intervals lubrication is required.

⚠ Even if you do not want to keep a maintenance book, you must check the lubrication of the treadmill belt at least once a week!

If the treadmill is not used, or if the treadmill remains folded-up for some longer period you must check the lubrication of the belt before use and lubricate it if necessary.

To achieve optimum lubrication of the belt use the MAXXUS maintenance oil bottle, remove the normal screw bottle top (Diagram 1) and screw on the thin tube top (Diagram 2). Before lubricating the belt, make sure that the treadmill is switched-off and that the belt is no longer moving. Lift up the belt (Diagram 3).

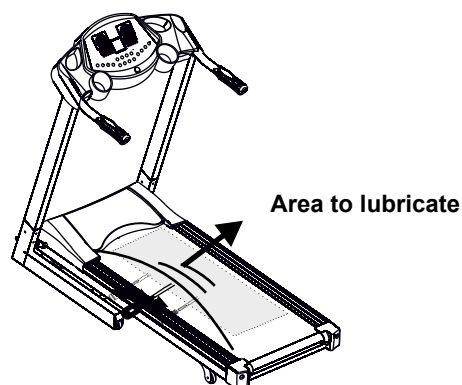
Diagram 1



Diagram 2

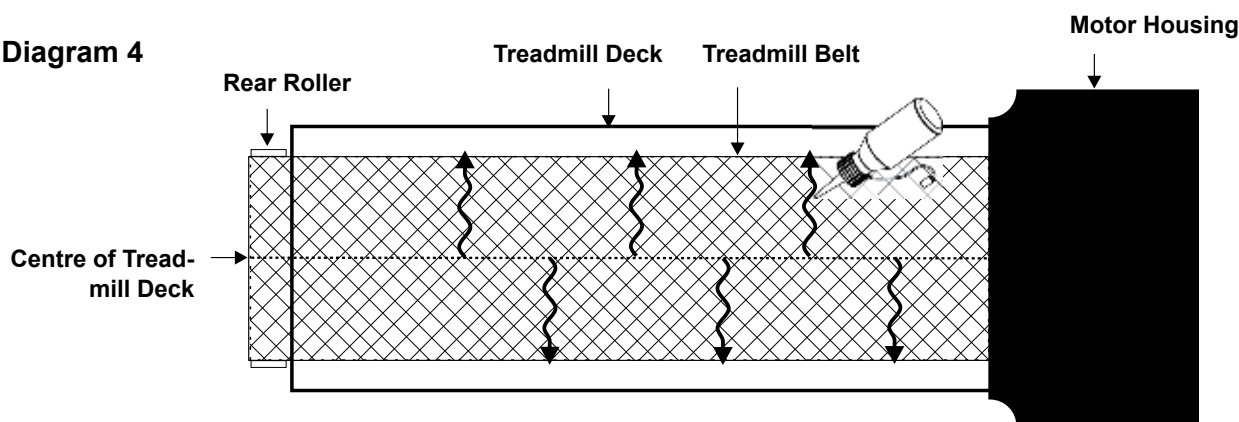


Diagram 3



The belt should be lubricated from both sides. Lift up the belt from one side high enough so that you can reach the middle of the belt with the end of the thin tube on the silicone oil bottle. Apply a wavy line of silicone oil from the middle of the belt towards the sides. You should apply three to four lines of silicone oil running from the middle of the belt to the sides. At each lubrication process you should not apply more than 10 to max 20ml of silicone oil. If too much silicon is applied this may lead to the treadmill belt slipping through. In this case remove the excess oil from the deck and drive rollers with a dry cloth.

Diagram 4



⚠ CAUTION:

Only use the silicone bottle supplied or MAXXUS® maintenance oil (available from www.maxxus.com) to lubricate the treadmill belt. Do not use any other kinds of silicone or lubricants! We do not recommend the use of silicone sprays at any time!

After completing a lubrication process let the belt run without any load at a speed of 4 km/h for approx. 5 minutes to distribute the silicone oil well.

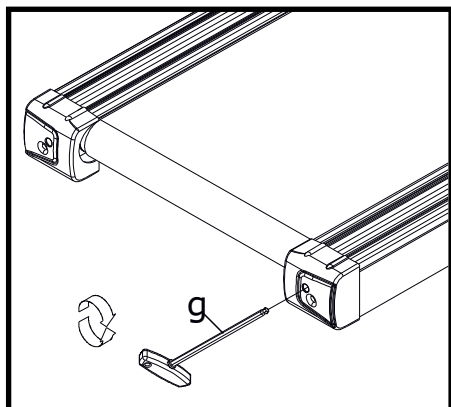
⚠ After lubrication do not fold up the treadmill for at least 3 days.

! The treadmill belt must always be switched off with the mains cable plug removed from the socket before starting any maintenance, cleaning, repairs or any other works!

Adjusting the Treadmill Belt

To achieve as long a service life as possible, the belt should always be kept running straight along the centre of the deck. Check therefore before each training session if the belt is straight and running in the middle of the deck or if it has changed position. Possible reasons for it changing position are:

- The ground on which the treadmill is standing is either uneven or at an incline.
- Personal running style (eg. distribution of weight to one side, in or out-turned feet etc)



The treadmill belt can be adjusted in the following way:

1. Start-up the treadmill belt and let it run at a constant speed of 4 km/h.
- 2.1 If the belt is running towards the left, turn the left adjustment screw located at the back end of the belt by 1/8 turn clockwise and the right adjustment screw 1/8 turn anti-clockwise. Wait for a short while to see the results as this will not immediately be apparent.

! The running direction of the belt will be changed with just a turn of 1/8 of the adjustment screw. Therefore, only adjust the screws a little at a time.

- 2.2 If the belt is running towards the right, turn the right adjustment screw by 1/8 turn clockwise and the left adjustment screw 1/8 turn anti-clockwise.
3. If the belt is now running in the middle of the deck, the adjustment will be correct. If this is still not the case, repeat the steps described in 2.1 and 2.2 until the belt is running in the middle.

If the belt cannot be adjusted, please contact a specialist immediately.

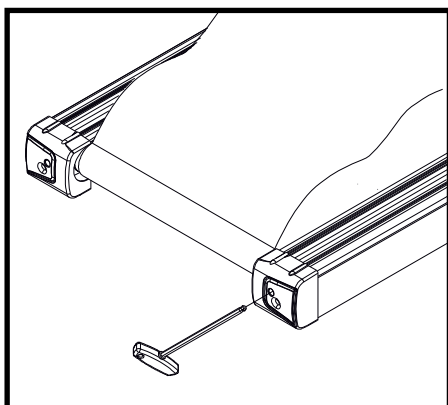
! If the belt has become so displaced that it is rubbing along one of the foot rails, this will cause friction and defects to the treadmill belt. Damage caused by failure or insufficient adjustments made to the treadmill belt will not be covered by the warranty or guarantee under any circumstances.

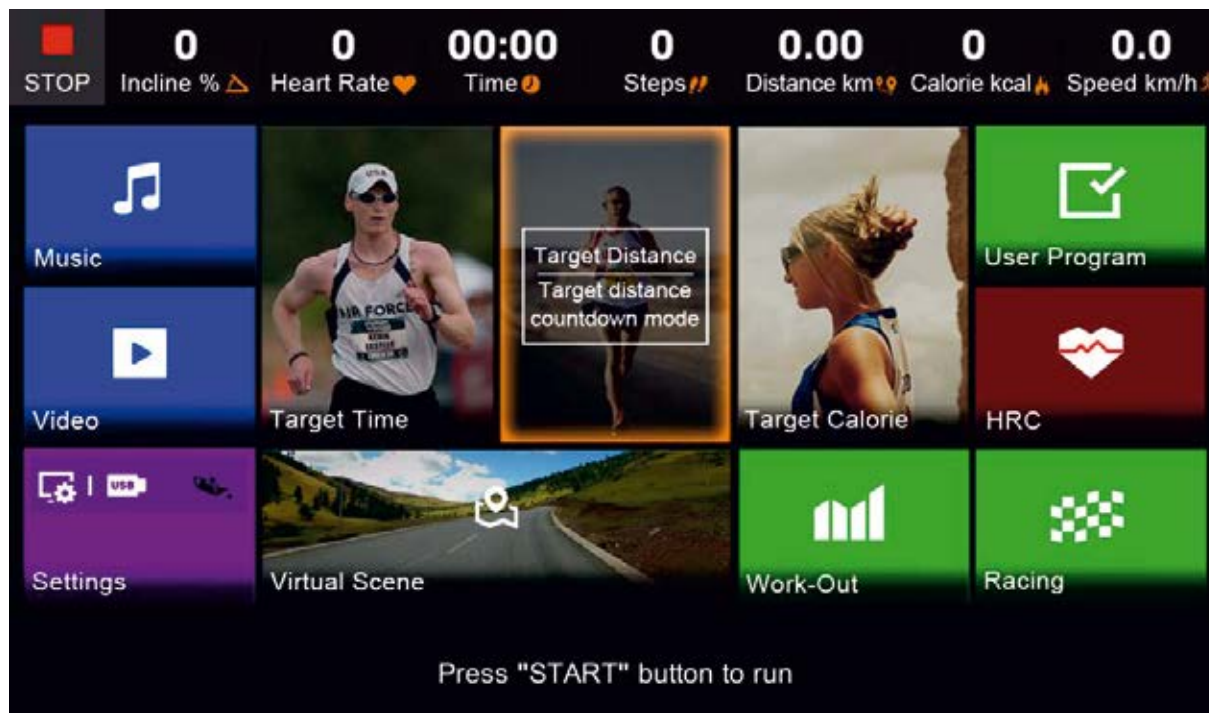
ENG

Re-tensioning the Treadmill Belt


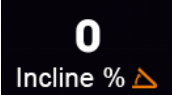





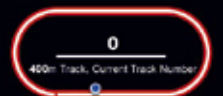
If the belt is slipping on the drive rollers during operation (this will be made apparent by the belt jolting noticeably during running) the belt requires to be re-tensioned. The belt is re-tensioned using the same adjustment screws as when adjusting the belt.

1. Start-up the treadmill belt and let it run at a constant speed of 4 km/h.
2. Turn one adjustment screw after the other by 1/8 of a turn in a clockwise direction.
3. Try to slow down the belt by walking on it as if you are walking down a steep slope. If the front roller is still turning, repeat the tensioning process once again. The treadmill belt should be tensioned so that the front roller only turns with heavy braking.





1.1 Symbols

	<p>SPEED - Displays the current speed from 0.8 to 20.0km / h</p>
	<p>Incline - Displays the current incline from level 0 to 15.</p>
	<p>Distance - Displays the training distance from 0.00 to 99.99km</p>
	<p>Time - Displays the training time from 0:00 to 18 hours</p>
	<p>Steps - Displays the number of steps completed from 0 to 99,999 steps</p>
	<p>Calorie – Displays the number of calories consumed from 0.0 to 999 calories *</p>
	<p>Heart Rate When using the hand pulse sensors: Display of the current pulse rate When using a transmitter chest strap **: Displays the current heart rate</p>
	<p>400 Metre Track + Lap Counter Displays the position of the user (blue dot) on a 400 Metre track and the number of completed 400-metre laps.</p>




*** Note on calorie measurement**









The calculation of energy consumption is done by means of a general formula. It is not possible to determine an individual energy consumption exactly as this requires a large amount of personal data. The displayed energy consumption is an approximation, not an exact value.

**** Note on heart rate measurement**



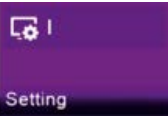




Transmitter chest belt not included.

1.2 Keypad

	<> Keys for selecting functions and programs and for entering values
	ENTER Key for confirming selections and entries
Home	Home Key to return to the main menu
Back	Back Key to jump back one menu item
Incline 	Incline Keys to regulate the incline
SPEED +/-	SPEED Speed adjustment keys
START	START Key for starting the current exercise program or the quick start function
STOP	STOP Key for ending the current training
PAUSE	PAUSE Key for interrupting the current training
Direct dial SPEED	Direct dial SPEED Speed dial keys for speeds 6, 8 and 10 km / h
Direct dial INCLINE	Direct dial INCLINE Speed dial keys for incline levels 3, 5 and 7

 <p>Target Time</p>	<p>Target Time - Target training time</p>
 <p>Target Distance</p>	<p>Target Distance - Target training distance</p>
 <p>Target Calorie</p>	<p>Target Calorie - target calorie consumption</p>
 <p>User Program</p>	<p>User program 6 free memory slots for creating and saving individual training profiles</p>
 <p>HRC</p>	<p>HRC program Heart-rate controlled training program</p>
 <p>Virtual Scene</p>	<p>Virtual Routes (Virtual Scene) There are 6 virtual running tracks available</p>
 <p>Racing</p>	<p>Competition simulation (Racing) 12 competition simulations allow you to compete against a virtual opponent</p>
 <p>Work-Out</p>	<p>Training profiles (Work-Out) Selection of 12 pre-programmed training profiles</p>

1.3 Multi-Media Functions

 <p>Music</p>	<p>Music Play saved audio files from an external USB stick * *not included in the delivery</p>
 <p>Video</p>	<p>Video Player saved video files from an external USB stick * *not included in the delivery</p>
 <p>Setting</p>	<p>Setting System settings for screen brightness</p>
	<ul style="list-style-type: none">  Indicator lights up as soon as a USB stick is connected  The indicator lights up as soon as the Bluetooth connection to a known device has been established  The indicator lights up as soon as the treadmill lubrication requires to be checked

More functions

Hand Pulse Sensors

Used for short-term pulse control. Cover the hand sensors with both hands. After a short while the current pulse is shown in the display. Please also read the chapter “Pulse Measurement using Hand Sensors” and “Warning on Heart Rate Measurement” in this manual.

Heart Rate Measurement

The cockpit of this treadmill is factory fitted with a receiver for wireless heart rate measurement for which an optional transmitter chest belt is needed. This chest belt must be 5 kHz frequency and uncoded. MAXXUS® recommends using a POLAR® T34 Transmitting Belt. The use of Bluetooth chest belts is not possible. Please also read the chapter “Pulse Measurement using Hand Sensors” and “Warning on Heart Rate Measurement” in this manual.

Line-in Connection & Speakers

The cockpit of the treadmill is equipped with a line-in connection and speakers. The line-in cable (included) allows you to connect an external music source (eg smartphone, MP3 player, etc.) and play the audio source through the speakers. The volume is regulated via the externally connected device. Sound control via the cockpit is not possible.

USB Connection

Socket for a USB stick (not included)

Switch the Treadmill On

Connect the mains plug of the power cable to a grounded, individually fused 16 A socket installed by a specialist then switch on the treadmill with the on / off key (located on the back of the motor housing).

Switch the Treadmill Off

To switch off the treadmill, press the on / off key then remove the mains plug from the socket.

CAUTION:

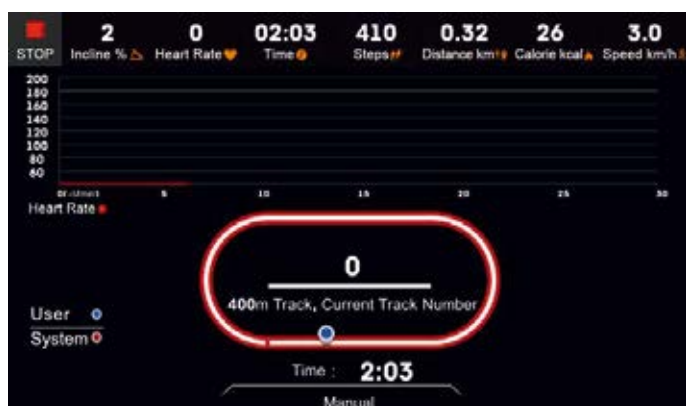
Before you switch off the treadmill always make sure that the incline is at level zero.

Quick Start

Turn on the treadmill and press the START key.

The treadmill starts automatically after a countdown and the exercise time starts to run. The user can regulate the speed and incline directly.

ENG



To end the workout, press the STOP key. The treadmill stops and the display shows a summary of the workout values.

The summary information shows:

- Exercise Time
- Exercise Distance
- Calorie Consumption
- Average Speed
- Number of Steps

Manual Training

The user specifies a training goal. The value begins to count-down backwards when training starts. When the value reaches zero, training will be terminated automatically. Training time, training distance or calorie consumption may be selected as a training goal.

Step 1: Program selection

Turn on the treadmill and use the < > v keys to select the appropriate icon for the desired training target:



Target time



Target Distance



Target Calories

Confirm your selection by pressing the ENTER key.

Step 2: Specification of the selected training goal

Step 2.1: Specification of training time

The display shows "30:00" minutes

Enter the desired workout time from 5 minutes to 600 minutes by pressing the < > keys in 1-minute increments.

Proceed to step 3.

Step 2.2: Specification of training distance

The display shows "2.00 km"

Enter the desired workout distance of 0.5 to 100 kilometres by pressing the < > keys in 0.5-kilometre increments.

Proceed to step 3.

Step 2.3: Specification of calorie consumption

The display shows "50 kcal".

Enter the desired calorie consumption from 5 to 1,000Kcal by pressing the < > keys in 5kcal increments.

Then proceed to step 3.

Step 3: Training start

After entering the desired training target, press the START key.

The display will show a countdown. When the countdown ends, the treadmill starts automatically.

Use the SPEED keys to adjust the speed, and the INCLINE keys to adjust the incline during the workout. Training ends automatically on reaching the training goal. The end of the training session is indicated by a sound signal. After completion of training a summary of the training values appears.

Free Memory Slots (User Program 1 - 6)

The user can create and save their own training profiles, there are 6 free memory slots available for individual training profiles.

Each training profile consists of 16 segments. The total training time specified by the user determines the duration of the segments (training time/16 = individual time per segment).

Step 1: Program selection

Switch on the treadmill and select User Program with the keys < >. Confirm your selection by pressing the ENTER key.



Step 2: Choosing Free Space (User program 1 - 6)

Select the desired memory location with the < > v keys. Confirm your selection by pressing the ENTER key.

Step 3: Specification of training time

The lower part of the display shows "Set Time: 30:00".

Enter the desired workout time from 5 minutes to 600 minutes by pressing the < > keys.

Note: The given training time determines the length of the 16 individual segments.

The training time is divided by 16, e.g. 32 minutes = 2 minutes per segment.

Step 4: Specification of the training profile

Each of the 6 free memory locations is divided into 16 segments for Incline (orange segments) and Speed (blue segments). The first segment for incline and speed are flashing.

Enter the desired incline speed for the first segment using the Incline and SPEED keys. Confirm your selection by pressing the ENTER key.

Proceed with segments 2 through 16 as described for the first segment and specify the incline and speed values for all segments.

After entering the values for the 16th segment, do not press the ENTER key but continue with step 5.



Step 5: Training start

Press the START key. When the countdown ends, the treadmill starts automatically. Training ends automatically at the end of the given training time. The end of the training session is indicated by a sound signal. After completion of the training a summary of the training values is displayed.

Virtual Routes (Virtual Scene)

The user has 6 different routes to choose from.

The playback speed of each video automatically adjusts to the treadmill speed.

Step 1: Program selection

Turn on the treadmill and use the < > v keys to select the Virtual Scene icon. Confirm your selection by pressing the ENTER key.



Step 2: Selection of the virtual running distance

Select the desired running distance by pressing the < > v keys.

Step 3: Training start

Press the START key. When the countdown ends, the treadmill starts automatically.



Use the SPEED keys to adjust the speed, and the INCLINE keys to adjust the incline during the workout.

To stop training press the STOP key. After completion of the training a summary of the training values appears.

Competition Simulation (RACING)

The user has 12 different competition simulations to choose from in which they compete against a computer opponent

Step 1: Program selection

Switch on the treadmill and select Racing with the keys < > v.
Confirm your selection by pressing the ENTER key.



Step 2: Selection of the competition simulation

Select the desired competition simulation by pressing the < > v keys.

Step 3: Specification of the training time

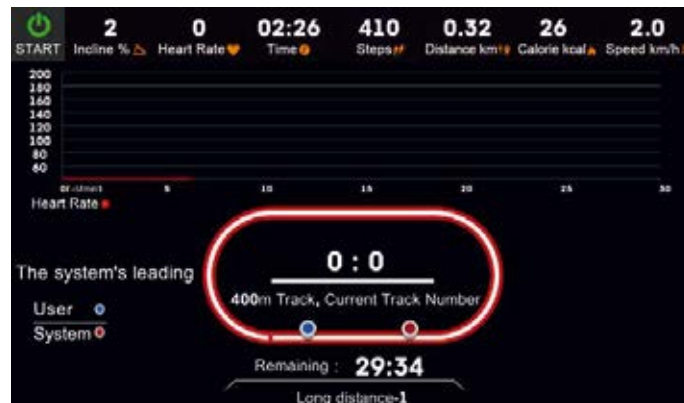
The display shows "Set Time: 30:00".

Enter the desired workout time from 5 minutes to 600 minutes by pressing the < > keys.

Note: The training time determines the length of the individual 16 segments
The training time is divided by 16, e.g. 32 minutes = 2 minutes per segment.

Step 4: Training start

Press the START key. When the countdown ends, the treadmill starts automatically.















Once you start the program, your computer opponent starts. The corresponding speeds of the opponent for the individual segments can be found in the following table.

You regulate your speed individually using the SPEED keys.

The current position of the opponent and the user are displayed graphically with dots (blue = user / red = opponent) on the 400-metre track.

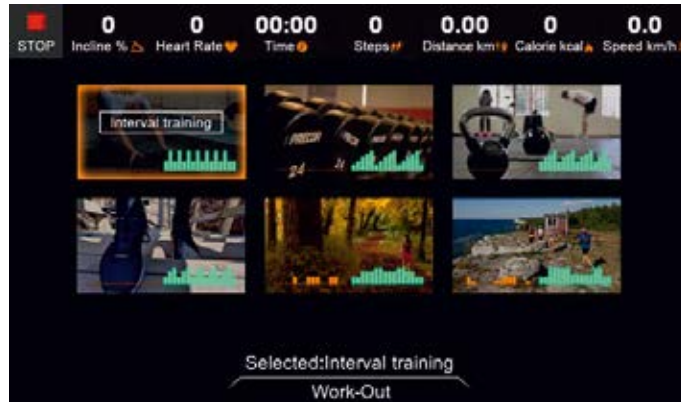
Training ends automatically when the training time has elapsed. The end of training is indicated by a sound signal.

Speed in km / h for the 16 segments (stages) of the individual racing programmes																	
 Long distance-1	Stage	1	2	3	4	5	6	7	8	9	10	11	12	13	14	15	16
	Speed	4	4	8	8	8	8	8	8	8	8	8	8	8	8	8	4
 Cross	Stage	1	2	3	4	5	6	7	8	9	10	11	12	13	14	15	16
	Speed	6	6	10	10	10	12	12	12	10	10	10	8	8	8	6	6
 Interval-1	Stage	1	2	3	4	5	6	7	8	9	10	11	12	13	14	15	16
	Speed	8	8	12	8	12	8	14	8	14	8	16	8	16	8	16	8
 Cross country-1	Stage	1	2	3	4	5	6	7	8	9	10	11	12	13	14	15	16
	Speed	6	6	10	10	10	10	10	10	10	10	10	10	10	10	10	6
 Cross country-2	Stage	1	2	3	4	5	6	7	8	9	10	11	12	13	14	15	16
	Speed	8	8	10	10	10	12	14	14	12	10	10	10	10	10	10	8
 Interval-2	Stage	1	2	3	4	5	6	7	8	9	10	11	12	13	14	15	16
	Speed	4	4	12	4	12	4	14	4	14	4	16	4	16	4	16	4
 Relaxation training	Stage	1	2	3	4	5	6	7	8	9	10	11	12	13	14	15	16
	Speed	4	4	4	4	4	4	4	4	4	4	4	4	4	4	4	4
 Aerobic training	Stage	1	2	3	4	5	6	7	8	9	10	11	12	13	14	15	16
	Speed	4	6	8	8	6	6	10	10	8	8	6	6	8	8	6	4
 High speed training	Stage	1	2	3	4	5	6	7	8	9	10	11	12	13	14	15	16
	Speed	8	12	12	14	14	16	16	14	14	12	12	10	10	8	8	6
 Long distance-2	Stage	1	2	3	4	5	6	7	8	9	10	11	12	13	14	15	16
	Speed	8	8	8	8	8	8	8	8	8	8	8	8	8	8	8	8
 Middle distance	Stage	1	2	3	4	5	6	7	8	9	10	11	12	13	14	15	16
	Speed	6	8	8	8	10	10	10	12	12	12	10	10	10	8	8	6
 Interval-3	Stage	1	2	3	4	5	6	7	8	9	10	11	12	13	14	15	16
	Speed	6	6	12	6	12	6	12	6	12	6	12	6	12	6	12	6

Training with training profiles (Work-Out)

Step 1: Program selection

Turn on the treadmill and use the < > v keys to select the Work-Out icon. Confirm your selection by pressing the ENTER key



Step 2: Selection of training profiles

Select the desired workout profile by pressing the < > v keys. Confirm your selection by pressing the ENTER key.

Step 3: Specification of the training time

The display shows "Set Time: 30:00".

Enter the desired workout time from 5 minutes to 600 minutes by pressing the < > keys.


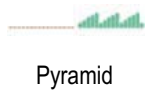
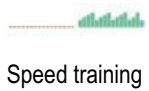
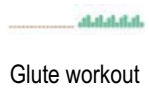

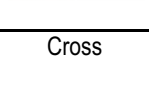






Note: The training time determines the length of the individual 16 segments. The training time is divided by 16, e.g. 32 minutes = 2 minutes per segment.



Step 4: Training start

Press the START key. When the countdown ends, the treadmill starts automatically. Training ends automatically when the training time is achieved. The end of the training session is indicated by a sound signal. After completion of training a summary of the training values appears.



Speed in km / h and incline for the 16 segments (stages) of the individual racing programmes																	
 Interval training	Stage	1	2	3	4	5	6	7	8	9	10	11	12	13	14	15	16
	Speed	6	12	6	12	6	12	6	12	6	12	6	12	6	12	6	6
	Incline	0	0	0	0	0	0	0	0	0	0	0	0	0	0	0	0
 Pyramid	Stage	1	2	3	4	5	6	7	8	9	10	11	12	13	14	15	16
	Speed	4	6	8	10	12	4	6	8	10	12	4	6	8	10	12	4
	Incline	0	0	0	0	0	0	0	0	0	0	0	0	0	0	0	0
 Speed training	Stage	1	2	3	4	5	6	7	8	9	10	11	12	13	14	15	16
	Speed	6	8	10	12	6	8	10	12	6	8	10	12	6	8	12	6
	Incline	0	0	0	0	0	0	0	0	0	0	0	0	0	0	0	0
 Glute workout	Stage	1	2	3	4	5	6	7	8	9	10	11	12	13	14	15	16
	Speed	4	8	10	4	8	10	4	8	10	4	8	10	4	8	10	4
	Incline	0	0	0	0	0	0	0	0	0	0	0	0	0	0	0	0
 Aerobic exercise	Stage	1	2	3	4	5	6	7	8	9	10	11	12	13	14	15	16
	Speed	4	4	8	8	8	10	10	8	8	8	10	10	8	8	4	4
	Incline	0	0	0	0	4	0	0	4	4	4	0	0	4	4	0	0
 Cross	Speed	4	4	10	10	10	10	10	6	6	6	6	6	10	10	4	4
	Incline	0	4	2	0	0	0	0	2	2	4	4	4	0	0	2	0
 Lose weight	Stage	1	2	3	4	5	6	7	8	9	10	11	12	13	14	15	16
	Stage	6	6	6	10	10	10	12	12	12	10	10	10	6	6	6	6
	Speed	0	0	0	0	0	0	0	0	0	0	0	0	0	0	0	0
 Calorie burn	Incline	1	2	3	4	5	6	7	8	9	10	11	12	13	14	15	16
	Stage	8	8	8	8	8	8	12	12	12	12	8	8	8	8	8	8
	Speed	0	0	0	0	0	0	0	0	0	0	0	0	0	0	0	0
 Uniform training	Incline	1	2	3	4	5	6	7	8	9	10	11	12	13	14	15	16
	Stage	8	8	8	8	8	8	8	8	8	8	8	8	8	8	8	8
	Speed	0	2	4	6	0	2	4	6	0	2	4	6	0	2	4	6
 Power walk	Stage	1	2	3	4	5	6	7	8	9	10	11	12	13	14	15	16
	Speed	6	6	6	6	8	8	8	8	6	6	6	6	8	8	8	8
	Incline	0	0	0	0	2	2	2	2	2	2	2	2	0	0	0	0
 Fitness test	Stage	1	2	3	4	5	6	7	8	9	10	11	12	13	14	15	16
	Speed	8	8	8	8	10	10	10	10	8	8	8	8	10	10	10	10
	Incline	0	0	0	0	0	0	0	0	0	0	0	0	0	0	0	0
 Hill run	Stage	1	2	3	4	5	6	7	8	9	10	11	12	13	14	15	16
	Speed	6	6	6	6	6	6	6	6	6	6	6	6	6	6	6	6
	Incline	2	4	6	8	2	4	6	8	2	4	6	8	2	4	6	8

Heart-rate controlled programs - HRC1 and HRC2

These are heart-rate controlled training programs.

For HRC 1, the user specifies a desired target heart rate. This is continuously compared with the actual heart rate of the user by the cockpit. If the actual heart rate is lower than the desired target heart rate, the treadmill automatically increases the speed or the incline selected by the user. If the value is higher, the treadmill automatically reduces the speed or incline.

HRC 2 is interval training based on upper and lower target heart rates. Target heart rates are set at the lower and upper limits. Once a value has been reached by changing the speed or incline, it is held constant for 2 minutes and then the cockpit changes speed or incline to reach the second value. This is also held for 2 minutes. The difference between the two values is 20 beats / minute.

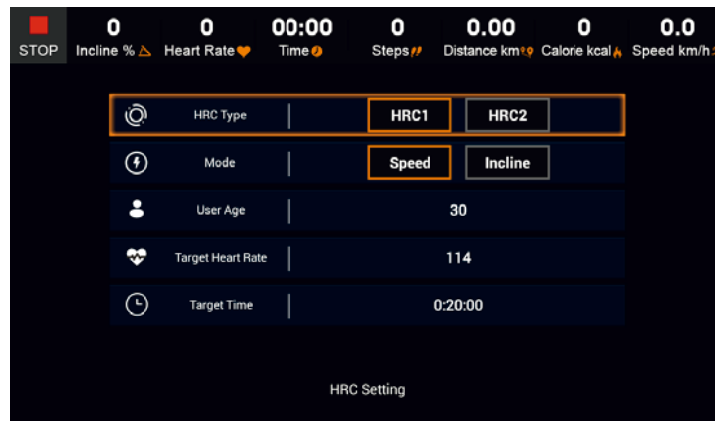
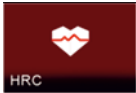
The main requirement for this program is a constant, accurate transmission of heart rate values. For this reason, this program can only be used with an uncoded heart rate chest belt. This is available as an accessory. The use of this program is not possible with hand pulse sensors. Please also read the chapters “Heart Rate Measurement”, “Warning on Heart Rate Measurement “ in this manual.

Step 1: Program selection

Switch the treadmill on and use the < > v keys to select the HRC icon.

Confirm your selection by pressing the ENTER key.

To navigate through the individual option, press the v keys. Use the < > keys to make selections or enter values.



Step 2: Select the program

Select the desired program, HRC1 or HRC2 and confirm your selection by pressing the ENTER key.

Step 3: Select Speed and Incline

The user determines whether the increase or decrease in the actual heart rate is controlled by a change in speed or incline. Press the < > keys to select “Speed” for Speed and “Incline” for Incline. Confirm your selection by pressing the ENTER key.

Step 4: Age (Age)

Enter the age of the user here.

Step 5.1: Target Heart Rate - HRC 1

The cockpit displays the target heart rate in %, based on the user's age. The calculated value corresponds to 60% of the maximum heart rate. If you want to train with the calculated value, use the \vee key to change to the pre-set heart rate.

If you want to train with an individual target heart rate, enter it by pressing $< >$ keys. Please also read the chapters on pulse and heart rate measurement in this manual. Then switch to the pre-set heart rate by pressing the \vee key.

Step 5.2: Upper and Lower Limits of Target Heart Rate - HRC 2

The cockpit displays the lower limit of the target heart rate in %, based on your user age input. The calculated value corresponds to 60% of the maximum heart rate. The upper limit is 20 beats / minute more.

Example: age 30 years = lower limit 114, upper limit 134

If you want to train with the calculated values, use the \vee key to change to the pre-set time.

If you want to exercise with individual target heart rate values, enter them by pressing $< >$ keys. Please also read the chapters on pulse and heart rate measurement in this manual. Then switch to the pre-set time by pressing the \vee key.

Training Time (Target Time)

Enter the desired exercise time between 10 and 99 minutes.

Step 6: Training start

After you have set all values, press the START key. The display will show a countdown. The training time starts to run after the countdown and the treadmill starts automatically.

End of training

The treadmill stops automatically after the specified training time has elapsed.

Sequence Program HRC 1:

After the program has been started by pressing the START key, a 3 minute warm-up begins. The speed is 3.0 km / h and the incline is 5%.

After the warm-up phase, the actual training session begins. The speed is now 4.0 km / h and the incline 0%.

If Incline is selected, the treadmill will increase the incline by one level every 10 seconds until the desired target heart rate is reached. If the treadmill has reached the highest level and the user's actual heart rate is still below the desired target heart rate, the treadmill increases speed by 0.5 km / h every 10 seconds until the target heart rate is reached.

Once the target heart rate is reached, the treadmill does not change either incline or speed.

If the actual heart rate is higher than the target heart rate, the treadmill reduces the incline by one level every 10 seconds. If the incline is 0% and the actual heart rate is still higher than the target heart rate, the treadmill will reduce the speed by 0.5 km / h every 10 seconds.

If "Speed" is selected, the treadmill first changes the speed by 0.5 km / h every 10 seconds and then changes the incline if necessary.

Sequence Program HRC 2:

The treadmill behaves as previously described in HRC 1 in this program.

Once the actual heart rate has reached the upper limit of the target heart rate it will be held for 2 minutes.

Thereafter, the treadmill changes speed or incline to reach the lower limit. When this is reached, it is also held for 2 minutes. Then it changes to the upper limit again.



Use the < > v keys to select the Music icon and confirm your selection by pressing the ENTER key. Connect a USB stick with audio files (mp3 files). The titles are displayed in the menu.



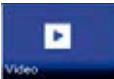
Key to play the music or to pause



Keys to jump forward or backward to the next song.



Keys to adjust the volume



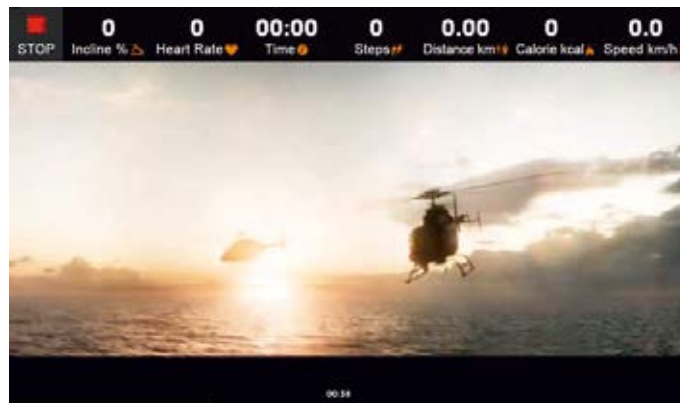
Use the < > v keys to select the Video icon and confirm your selection by pressing the ENTER key. Connect a USB stick with video files. The titles are displayed in the menu.



Key for playing video files and for pausing



Keys for adjusting the volume



ENG

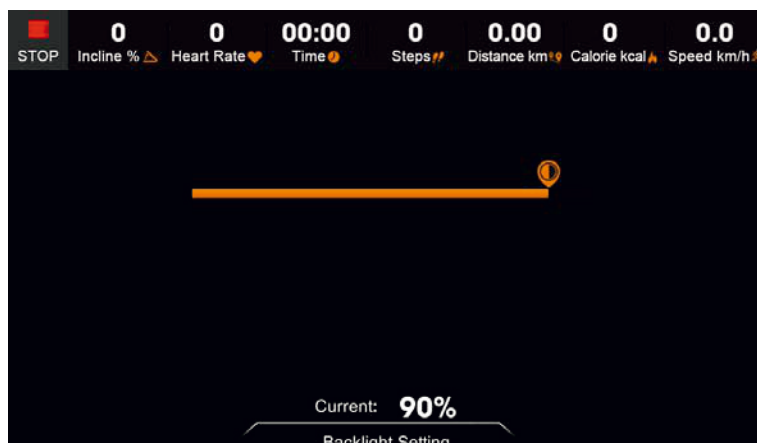
After the video has been started, the selection menu disappears after about 5 seconds. To display it again press one of these keys

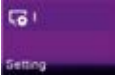


Press this icon to adjust the brightness of the display illumination.



Keys to adjust the brightness.



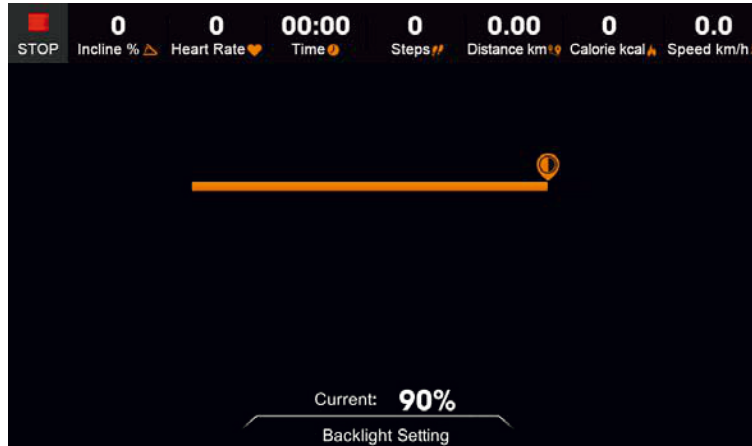


Use the < > v keys to select the Settings icon and confirm your selection by pressing the ENTER key.

In the “Settings” area, you have the option of changing the brightness level of the backlight.



Use the < > keys to select the backlight setting icon and confirm your selection by pressing the ENTER key. Set the desired brightness level by pressing the < > keys.



The Language Switching section should only be used if the factory setting is not in English. A German language version is not available.

The Engineering Mode area is a locked area available only to the service technician.

Fitness training with the FitShow App


The cockpit is fitted with a Bluetooth receiver as standard. Download the Fitshow App on a dedicated smartphone or tablet PC. To do this, scan the QR code on the back of this manual.

- Step 1:** Download the “FitShow” App from the App Store / Play Store and install it on your smartphone or tablet PC.
- Step 2:** Register with FitShow. Please use a valid e-mail address, as you will receive a confirmation code by e-mail.
- Step 3:** Make sure the treadmill is on and then go to “Indoor” at the top of the app selection and press “Search”. The treadmill will now be displayed. Once you have selected your treadmill, you have full access to the app.

Note:

Please note that we provide only the basis for using the device with an App. If you have any questions about the use of the app and / or the Smartphone or tablet PC you are using, please contact the respective provider directly.



 Heart Rate per Minute	200																
	150	195															
	130	146	190														
	110	127	143	185													
		107	124	139	180												
			105	120	135	175											
				102	117	131	170										
					99	114	128	165									
						96	111	124	160								
							94	107	120	155							
								91	104	116	150						
									88	101	113	145					
										85	98	109	140				
											83	94	105	135			
												80	91	101	100		
													77	88	98		
														74	85		
															72		
Age	20	25	30	35	40	45	50	55	60	65	70	75	80	85	90		

ENG

Calculating your personal heart rate when training

Calculate your personal heart rate when training as follows:

220 - Age = maximum heart rate

This value represents your maximum heart rate and serves as a basis from which to calculate your personal training heart rate. Set the calculated heart rate at 100%

Wellness and Health - target zones = 50 to 60% of the maximum heart rate.

This training zone is ideally suitable for people who are over-weight and/or older beginners, or people starting again after a longer break from training. Training in this zone the body will burn approx. 4-6 calories per minute to produce energy. The percentage ratio per calorie is approx. 70% fat, 25% carbohydrate, and 5% protein.

Fat burning - target zone = 60 to 70% of the maximum heart rate

This training zone is suitable for athletes and sports people who aim to lose weight. Training in this zone the body will burn approx. 6-10 calories per minute to produce energy. The percentage rate per calorie is approx. 85% fat, 10% carbohydrate, and 5% protein.

Condition & Fitness - target zone = 70 to 80% of maximum heart rate

This training zone is ideally suitable for athletes and sports people who aim to improve their stamina and/or condition. Training in this zone the body will burn approx. 10-12 calories per minute to produce energy. The percentage rate per calorie is approx. 35% fat, 60% carbohydrate, and 5% protein.

For optimum effects in training results you should calculate the average value of the selected target zone (also see above table):

Wellness & Health - target zone average value = 55% of maximum heart rate

Fat burning - target zone average value = 65% of maximum heart rate

Kondition & Fitness - target zone average value = 75% of maximum heart rate

Warning about Pulse and Heart Rate Monitoring

CAUTION: Pulse and heart rate monitoring systems may be inaccurate. Excessive training can cause serious injury or even death. If you feel unwell and / or faint, stop training immediately. Make sure all users of your exercise device are familiar with this information, understand it and apply it unconditionally.

Pulse Rate Monitoring using Hand Sensors

Most exercise equipment is equipped with hand pulse sensors. These are mostly in the cockpit or integrated into the handrails. These hand sensors are used for short-term determination of the pulse rate. To do this, you need to cover the sensors with both hands at the same time. After a short while, the display shows the current pulse rate. This measuring system is based changes in electrical skin resistance measured by the hand sensors due to the heartbeat which causes blood pressure fluctuations. These changes are summarized to a mean value and shown in the display as the current pulse rate.

CAUTION.

For large parts of the population, the pulse-induced skin resistance change is so minimal that usable values cannot be derived from the measurement results. Also callouses on the palms, damp hands and body shakes, which in many forms of exercise inevitable, prevents correct measurement. In such cases, the pulse value is displayed incorrectly or not at all.

Please check in the case of a faulty or failed measurement, whether this occurs only with one or with several people. If the display of the pulse does not work only in individual cases, the device is not defective. In this case we recommend the use of a chest belt to achieve a permanently correct pulse display. This is available as an accessory

Heart Rate Measurement using a Chest Belt

Many MAXXUS® training devices are already fitted with a receiver as standard.

Using a chest belt (we recommend the exclusive use of an uncoded POLAR® chest belt) allows you to wirelessly measure heart rate. The chest belt is available online as an accessory from www.maxxus.com.

This optimal, ECG-accurate type of measurement takes the heart rate by means of a transmitter chest belt directly from the skin.

The chest belt then sends the pulse via an electromagnetic field to the built-in cockpit receiver. We recommend you always use a chest belt for heart rate measurement during heart rate-controlled programs.

CAUTION

The determination of the current heart rate by means of the chest belt serves only to display the current heart rate during exercise. This value says nothing about the safety and effectiveness of the training. Also, this type of measurement is in no way designed or suitable for medical diagnostic purposes.

Therefore, discuss with your family doctor the most suitable procedure for you and create your exercise plan before you start exercising.

This applies especially to those who:

- have not been physically active for a long period of time
- are overweight
- are older than 35 years
- have too high or too low blood pressure
- have heart problems

If you are wearing a pacemaker or similar device, discuss this with your medical specialist before using a heart rate chest belt.

Preparation Before Training

Before you start training make sure that not only your training device is in perfect condition, your body must also be prepared for training. Therefore, if you have not done any endurance training for some time, you should consult your GP and undergo a fitness check-up. Also discuss your training target; they will certainly be able to give you valuable advice and information. This applies to people who are over 35, have problems with overweight, heart or circulatory system problems.

Training Plan

Essential to effective, target orientated, and motivating training is to have a forward-looking trainings plan. Plan your fitness training as an integral part of your daily routine. If you don't have a fixed plan, training can easily interfere with regular commitments or continually be put off to another unspecified time.

If possible, create a long term monthly plan and not just from day to day or week to week. A training plan should also include sufficient motivation and distraction during training sessions. An ideal distraction is to watch TV during training as this diverts your attention both visually and acoustically. Make sure that you reward yourself and set realistic targets such as to losing 1 or 2kgs in four weeks or to increase your training time by 10 minutes within two weeks for example. If you reach your targets, then reward yourself with a favourite meal which you have not allowed yourself till then.

Warm-Up Before Training

Warm-up on your training device for 3-5 minutes at minimum resistance. This will best prepare your body for the up-coming exertion in training.

Cool-Down After Training

Do not just get off your training device immediately the training session is finished. Like with the warm-up stage you should continue for 3-5 minutes at minimum resistance to cool down. After training you should stretch your muscles thoroughly.



Front Thigh Muscles

Support yourself with your right hand against the wall or on your training device. Bend your knee and raise your left foot backwards so you can hold it with your left hand. Your knee should be pointing straight down to the floor. Pull your leg backwards until you feel a light pulling in your thigh muscles. Hold this position for 10 to 15 seconds. Let your foot go and stand it back on the floor. Repeat the exercise with your right leg.

ENG



Inner Thigh Muscles

Sit on the floor. Pull the soles of your feet together in front of you raising your knees slightly. Grasp the upper sides of your feet and place your elbows on your thighs. Press your thighs down towards the floor with your arms until you feel a light pulling in your thigh muscles. Hold this position for 10 to 15 seconds. Make sure to keep your upper body straight throughout the exercise. Release the pressure from your thighs and slowly stretch out your legs to the front. Stand up slowly steadily.



Legs, Calves and Buttocks

Sit on the floor. Stretch out your right leg and bend your left leg to place the sole of your foot on your right thigh. Bend your top body over so you can stretch out your right hand to touch your right toes. Hold this position for 10 to 15 seconds. Let go of your toes and sit slowly and steadily up straight again. Repeat this exercise with your left leg.



Leg and Lower Back Muscles

Sit on the floor with your legs stretched out. Stretch forward with your hands and try to grasp the tips of your toes with both hands. Hold this position for 10 to 15 seconds. Let go of your toes and slowly and steadily sit back up straight again.

Training Recommendations

Hydration

Adequate hydration is essential before and during exercise. During a training session of 30 minutes it is possible to lose up to 1 litre of liquid. To compensate for this fluid loss apple spritzer mixed in the ratio of one-third apple juice to two-thirds mineral water is ideal since it contains electrolytes and minerals to replace those that the body loses through sweat. You should drink about 330 ml 30 minutes before the beginning of your training session. Take care to maintain balanced hydration during the workout.

Training Frequency

Experts recommend that you do endurance training 3-4 days a week to keep the cardiovascular system fit. Of course, the more you train, the faster you will achieve your set training goal. Note however, that you should plan sufficient training breaks during your workout plan, to give your body enough time for rest and regeneration. After each training session you should take at least one day off. Also for that fitness and endurance training: Less is more!

Exercise Intensity

In addition to the mistake of exercising too often, mistakes are made in the intensity of the training. If your training goal is to train for a triathlon or marathon, your training intensity will certainly be high. But since most people have training goals such as weight reduction, cardiac / exercise training, improvement of physical condition, stress reduction, etc. to strive for, training intensity to meet these goals should be adjusted. It makes most sense to work with the appropriate heart rate for the respective training goal. The information on the heart rate and the corresponding table in this manual will help you further.

Duration of the individual training session

For optimal endurance or weight reduction training, the duration of the individual training session should be between 25 and 60 minutes. Beginners and returnees should start with a low training period of 10 minutes or less in the first week and then slowly increase week by week.

Training Documentation

In order to design and evaluate your training effectively, you should prepare yourself a training plan in written form or as a computer table before starting your training

Here you should document training session. Data, such as distance, training time, brake force setting and pulse values should be recorded as well as personal data, e.g. body weight, blood pressure, resting heart rate (measured morning immediately after waking up) and personal well-being during exercise.

Enclosed you will find a recommendation for a weekly plan.

Calendar Week: ____ Year: 20 ____						
Date	Day	Exercise duration	Exercise distance	Calorie consumption	Ø Heart rate	Comments
	Monday					
	Tuesday					
	Wednesday					
	Thursday					
	Friday					
	Saturday					
	Sunday					
Week Result:						

Cockpit:

Display of:

- Time
- Distance
- Calorie consumption
- Speed
- Incline
- Pulse Rate (when using hand sensors)
- Heart Rate (when using a chest belt which is available as an optional extra)

Technical details:

Motor:	DC motor
Constant motor power:	3.0 hp / 2.21 kW
Drive type:	Grooved belt
Speed:	0.8 - 20.0 km / h, adjustable in 0.1 km / h increments
Incline:	0 - 15%, electronically adjustable in 0.5% increments
Tread:	Approx. 1.400x51mm
Installation dimensions:	Approx. 1.795x880x1.525 mm (LxWxH)
Total weight:	Approx. 77kg
Maximum user weight:	120 kg
Power supply:	220-230V - 50Hz

Area of Application: Home Use – for private use only!

Disposal



European Disposal Regulations 2012/19/EU

Do not dispose your training device in the normal household rubbish. Dispose the device at a communal waste disposal facility or at a registered waste disposal company. Observe current regulations which apply accordingly. If in doubt seek advice from your local government office or county council as to where you can dispose of the device properly and in an environmentally sound manner.

Batteries / Rechargeable Batteries

Batteries and rechargeable batteries should never be disposed of in the household rubbish. Please be aware that all batteries can contain toxic substances and all consumers are obliged by law to dispose these at an appropriate collection point either at your local government office, county council or retail outlet. If in doubt seek advice from your local government office or county council as to where you can dispose batteries properly and in an environmentally sound manner. Only dispose of batteries when they are empty.

ENG

Recommended Accessories

These accessories are the perfect supplement for your training device. All products are available in our online shop at www.maxxus.com.

POLAR® Transmitter Chest Belt T34 (uncoded)

Chest strap for determining the heart rate with optimized transmission ranges. Required accessory for the application of pulse-controlled programs and for continuous determination of the current heart rate.



MAXXUS® floor protection mat

The extreme high density of material and 0.5 cm thickness of this floor mat, gives protection against damage, scratches and dirt due to sweat, liquids and movement. Noises are greatly minimized.

Available in following sizes:

- 210 x 100 cm - suitable for treadmills
- 240 x 100 cm – suitable for treadmills



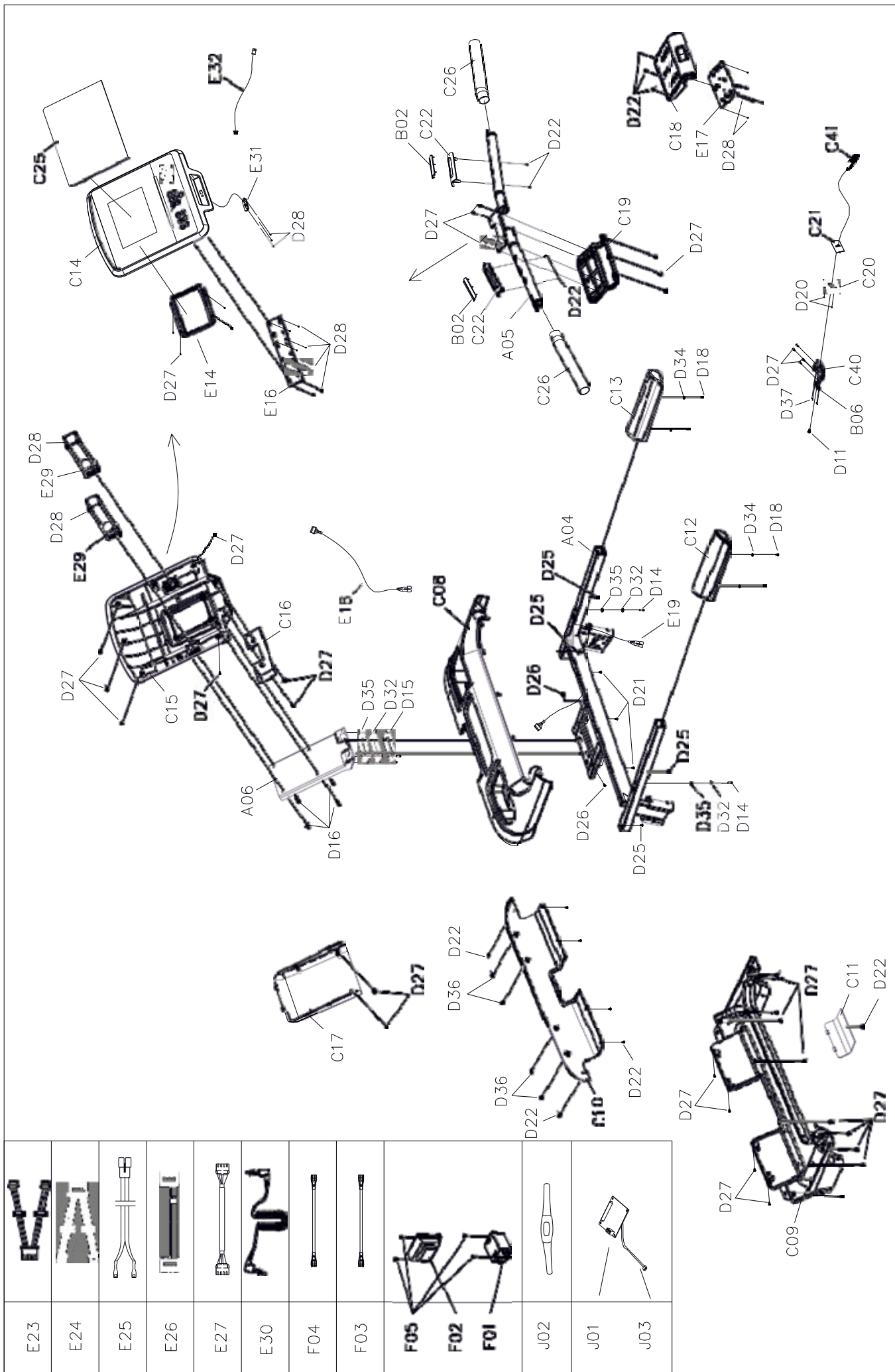
MAXXUS® Silicone

Optimal lubricant and release agent for running belt and running deck.

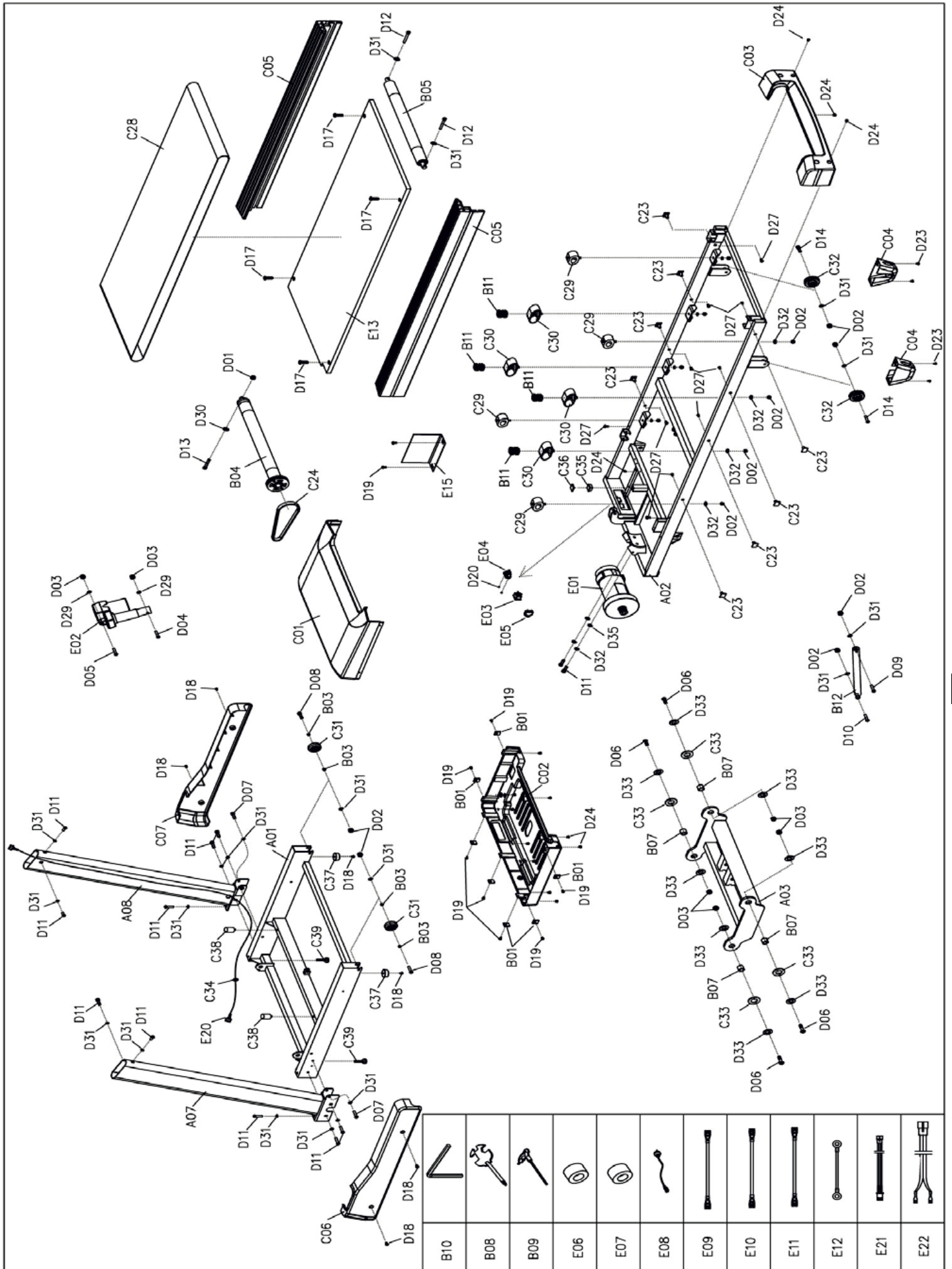
Available in the following sizes:

- 50 ml
- 250 ml





E23	
E24	
E25	
E26	
E27	
E30	
F04	
F03	
F05	
F02	
F01	
J02	
J01	
J03	



ENG

Spare Parts List

Part No.	Description	Specification	Qty
A01	Bottom frame		1
A02	Mainframe		1
A03	Incline frame		1
A04	Display frame		1
A05	Handlebar frame		1
A06	Display support frame		1
A07	Left column		1
A08	Right column		1
B01	Motor cover fixation board		7
B02	Handle pulse sheet		4
B03	Transportation wheel sleeve		4
B04	Front roller		1
B05	Rear roller		1
B06	Shrapnel		2
B07	Sleeve		4
B08	Cross solid wrench		1
B09	Inner hex wrench		1
B10	#5 Allen wrench		1
B11	Pressing spring		4
B12	Air cylinder		1
C01	Motor top cover		1
C02	Motor bottom cover		1
C03	Rear cover		1
C04	Adjustable wheel cover		2
C05	Side rail		2
C06	Left bottom cover		1
C07	Right bottom cover		1
C08	Display frame top cover		1
C09	Display frame bottom cover		1
C10	Display frame rear cover		1
C11	Small bottom cover		1
C12	Left foam handlebar		1
C13	Right foam handlebar		1
C14	Front panel		1
C15	Bottom panel		1
C16	Front panel support		1
C17	Bottom panel support		1
C18	Front key board		1

Part No.	Description	Specification	Qty
C19	Bottom key board		1
C20	Safety key seat		1
C21	Safety key		1
C22	Handle pulse seat		2
C23	Side rail fixation seat		8
C24	Motor belt		1
C25	Display acrylic		1
C26	Front handlebar foam		2
C28	Running belt		1
C29	Cushion pad		4
C30	Elliptical cushion pad		4
C31	Transportation wheel		2
C32	Adjustable wheel		2
C33	Plastic washer		4
C34	Annular plug		2
C35	Square end cap		1
C36	EVA pad		1
C37	Plain foot pad		2
C38	Cylinder cushion pad		2
C39	Adjustable foot pad		2
C40	Safety key jack		1
C41	Safety key clip		1
D01	Nonmetal hex lock	M6	1
D02	Nonmetal hex lock	M8	14
D03	Nonmetal hex lock	M10	6
D04	Bolt	M10x90 L20	1
D05	Bolt	M10x45 L20	1
D06	Bolt	M10x30 L15	4
D07	Bolt	M8x55 L20	2
D08	Bolt	M8x50 L20	2
D09	Bolt	M8x45 L20	1
D10	Bolt	M8x25 L15	1
D11	Bolt	M8x15	15
D12	Bolt	M8x65	2
D13	Bolt	M6x60	1
D14	Bolt	M8x40	4
D15	Bolt	M8x15	4
D16	Bolt	M6x15	4
D17	Bolt	M8x25	4
D18	Bolt	M5x16	10
D19	Bolt	M5x12	9

Part No.	Description	Specification	Qty
D20	Screw	ST2.9x8	4
D21	Screw	ST4.2x60	3
D22	Screw	ST4.2x12	18
D23	Screw	ST4.2x20	4
D24	Screw	ST4.2x12	15
D25	Screw	ST4.2x30	2
D26	Screw	ST4.2x25	2
D27	Screw	ST4.2x12	52
D28	Screw	ST2.9x8	34
D29	Lock washer	10	2
D30	Lock washer	6	1
D31	Lock washer	8	20
D32	Spring washer	8	16
D33	Big washer	$\phi 10*\phi 26*2.0$	8
D34	Big flat washer	$\phi 6*\phi 12*1.0$	4
D35	Flat washer	8	8
E01	DC motor		1
E02	Incline motor		1
E03	Square switch		1
E04	Power outlet		1
E05	Overload protector		1
E06	Magnet ring		1
E07	Magnet core		1
E08	Power cable		1
E09	AC wire	Length 200 brown	1

Part No.	Description	Specification	Qty
E10	AC wire	Length 350 brown	2
E11	AC wire	Length 350 blue	2
E12	Earthed wire	Yellow and green	1
E13	Running board		1
E14	Display		1
E15	Control board		1
E16	Keyboard plate		1
E17	Front keyboard plate		1
E18	Display upper wire		1
E19	Display middle wire		1
E20	Display bottom wire		1
E21	Pulse upper wire		1
E22	Pulse bottom wire		2
E23	Control panel upper wire		1
E24	Control panel bottom wire		1
E25	Safety key switch cable		1
E26	Center keyboard wire		1
E27	Audio signal input wire		1
E29	Speaker		2
E30	Mp3 connection wire		1
E31	USB module		1
E32	USB power wire		1

ENG

Part No.	Description	Specification	Qty
F01	Filter		1
F02	Inductor		1
F03	AC wire length 350mm		1
F04	Earthed wire length 350mm		1
F05	Screw ST4.2x12		4
J01	Wireless heart rate receiver		1
J03	HRC connection wire		1

For MAXXUS® Support Team to help you as quickly as possible with service, we will require certain information about your fitness device and about you. To find the exact spare parts required, we will need the product name, date of purchase and serial number.

If necessary, please fill out completely the Service Contract form attached to this User Manual and send it to us by post or you are welcome to use our online form "Service Contract" which you will find under the "Service" section at www.maxxus.com

Areas of Application & Warranty Periods

Depending on the model, fitness devices from MAXXUS® are suitable for use in different areas. Find the appropriate area of use for your fitness device from the "Technical Data" in this User Manual.

Home Use:

Exclusively for private use
Warranty Period: 2 Years

Semi-Professional Use:

Use under instruction in hotels, physiotherapy practices, etc.
Use in a fitness studio or similar establishment is hereby excluded!
Warranty Period: 1 Year

Professional Use:

Use in a fitness studio or similar establishment under supervision by trained personnel.
Warranty Period: 1 Year
Use of your training device in an area which is not suitable for your device will cause immediate expiry of its guarantee and cancel your right to claim warranty!
Sole private use and warranty period of 2 years assumes that the purchase invoice is made out to the end user.

Proof of Purchase and Serial Number

To claim your right to service works within the warranty period we will in each case require proof of purchase. Keep your proof of purchase or purchase invoice in a safe place and in warranty cases send us a copy together with your Service Contract. This will ensure that we can process the service work as quickly as possible. So that we can identify which model version requires to be serviced correctly, we will require; Product Name, Serial Number and Date of Purchase.

Terms and Conditions of Warranty:

The warranty period for your training device starts on the date of purchase and applies solely to products which were purchased directly from the MAXXUS Group GmbH & Co KG or one of the MAXXUS Group GmbH & Co KG direct and authorised distribution partners.

The warranty covers defects caused by production or material faults and only apply to devices purchased in Germany. The warranty does not apply to damages or defects caused by culpable improper use, negligent or purposeful destruction, lack or failure to carry out maintenance and/or cleaning measures, force majeure, operational causes and to normal wear and tear, damages caused by penetration of liquids, damage caused by repairs or modifications made with spare parts from a different supplier. The warranty also does not apply for damages due to faulty assembly or damages which occur because of faulty assembly. Certain component parts will wear out during use or from normal wear and tear. This includes for example:

- Ball bearings
- Bearing bushings
- Bearings
- Drive belts
- Rollers
- Switches and push-buttons
- Treadmill belts (bands)
- Treadmill decks (running deck)

Signs of wear and tear on wearing parts are not items covered under the warranty.

For assistance with warranty service or warranty repair enquiries for devices not in Germany, please contact our Service Department at MAXXUS Group GmbH & Co KGM by sending an Email to: service@maxxus.de and we will be happy to help.

Service Outside the Warranty and Ordering Spare Parts

The MAXXUS® Service Team is happy to be of assistance to help solve any problems with faults which may arise following expiry of the warranty period, or in cases of defects arising which are not covered by the warranty.

In this case please contact us by email direct to:

service@maxxus.de

Orders for Spare Parts or Worn Parts should be sent along with information on the Product Name, spare part description and number and the quantity required to:

spareparts@maxxus.de

Please be informed that additional fixing materials such as screws, bolts, washers etc are not included in the scope of delivery for individual spare parts. These should be ordered separately.



Device Details

Product Name: **RunMAXX 7.4** Product Group: **Treadmill**
 Serial Number: _____ Invoice Number: _____
 Date of Purchase: _____ Where Purchased: _____
 Accessories: _____ _____

Type of Use:

Private Use Commercial Use

Personal Details

Company: _____ Contact Person: _____
 First Name: _____ Second Name: _____
 Street: _____ House Number: _____
 Post Code / Town/City: _____ Country: _____
 E-Mail: _____ Tel.No.: _____
 Fax. No.*: _____ Mobile No.*: _____

* The fields marked with an asterisk are optional. The remaining fields are mandatory fields that must be completed.

Fault Description

Please enter a short description of the error as precisely as possible below:
 (For example, when, where and how does the error occur? Frequency, after which period, at what Use, etc)

ENG

- A copy of the proof of purchase / invoice / receipt is attached.
- I accept the General Terms and Conditions of MAXXUS® Group GmbH & Co. KG.

I hereby instruct the company MAXXUS® Group GmbH & Co. KG to repair the above defects. In Warranty cases I will not be charged for the cost. The costs for repairs which are excluded from liability for defects in quality will be charged to me and must be settled immediately. In cases of repairs carried out on site, our staff are entitled to collect payment. This agreement is confirmed with here with my signature.

Date
Location
Signature

Please be aware that contracts can only be processed if this form has been completed in full. Be sure to attach a copy of your purchase invoice. Send the fully completed Service Contract to:

Post*: Maxxus Group GmbH & Co KG, Service Department, Zeppelinstr. 2, 64331 Weiterstadt
Fax: +49 (0) 6151 39735 400
E-Mail**: customerservice@maxxus.com

* Please stamp with sufficient postage – letters which are not sent postage paid will unfortunately not be accepted.
 ** Submission by E-Mail is only possible as a scanned document with original signature.

You are welcome to use our online form “Service Contract” which you will find under the “Service” section at www.maxxus.com

MAXXUS[®]



 Bluetooth[™]



Maxxus Group GmbH & Co. KG
Zeppelinstr. 2
D-64331 Weiterstadt
Germany
E-Mail: info@maxxus.com
www.maxxus.com